

**GOVERNMENT OF TAMILNADU  
DIRECTORATE OF TECHNICAL EDUCATION  
CHENNAI – 600 025**

**STATE PROJECT COORDINATION UNIT**

**Diploma in Civil Engineering**

**Course Code: 1010**

**M – Scheme**

**e-TEXTBOOK**

**on**

**31042 Transportation Engineering**

**for**

**IV Semester DCE**

**Convener for CIVIL Discipline:**

**Thiru. N Muralikrishniah, M.E.,M.I.S.T.E.,**  
Principal / IPT &  
Principal (Addl. Charge)  
Central Polytechnic College,  
Taramani, Chennai – 600 113  
Email : muralinapa@gmail.com

**Team Members for Transportation Engineering:**

**Thiru T. Arulkumar, M.Tech.,**  
Lecturer, Department of Civil Engineering  
Central Polytechnic College, Chennai - 600 113

**Thiru. M. Jeevanandhan, M.E,**  
Lecturer, Department of Civil Engineering,  
136, Government Polytechnic College,  
Sethurapatti, Srirangam Tiruchirapalli- 620012

**Thiru. A. Balasubramaniyan, M.E,**  
Lecturer, Department of Civil Engineering,  
124, Government Polytechnic College,  
Keelakanavai, Perambalur - 621104

**Validated By**

**Thiru K. Sabapathy, B.Tech.Ed., M.I.E.,**  
HOD (Retd.),  
Department of Civil Engineering, Central  
Polytechnic College, Chennai - 600 113

**STATE BOARD OF TECHNICAL EDUCATION & TRAINING, TAMILNADU**

**DIPLOMA IN CIVIL ENGINEERING**

**M-SCHEME**

(To be implemented to the student admitted from the year 2015-2016 onwards)

Course Name : Diploma in Civil Engineering

Subject Code : 31042

Semester : IV Semester

Subject Title : **TRANSPORTATION ENGINEERING**

**TEACHING AND SCHEME OF EXAMINATION:**

No. of weeks per semester: 15 weeks

Subject Title	Instructions		Examination			Duration
	Hours / Week	Hours / Semester	Marks			
TRANSPORTATION ENGINEERING	5 Hrs	75 Hrs	Internal Assessment	Board Examination	Total	3 Hrs
			25	75	100	

**TOPICS AND ALLOCATION OF HOURS :**

Sl. No.	TOPIC	Time ( Hrs )
1	HIGHWAY ENGINEERING	13
2	HIGHWAY ENGINEERING ( Contd. )	13
3	RAILWAY ENGINEERING	13
4	RAILWAY ENGINEERING ( Contd. )	13
5	BRIDGE ENGINEERING	13
6	TEST AND REVISION	10
	<b>Total</b>	<b>75</b>

**RATIONALE:**

Construction of roads is one of the area in which diploma holders in Civil Engineering get employment. These diploma holders are responsible for construction and maintenance of highways. Basic concepts of road geo-metrics, surveys and plans, elements of traffic engineering, road materials, construction of rigid and flexible pavements, special features of hill roads, road drainage system and various aspects of maintenance find place in above course.

In addition, this subject will cater to the needs of those technicians who would like to find employment in the construction of railway tracks, bridges. The subject aims at providing broad based knowledge regarding various components and construction of railway track, bridges.

**OBJECTIVES:**

On completion of the course, the student will be familiar with:

- To study about the importance of the roads , Development of roads, Classification of roads
- To know about highway pavements , Geometrical design , Traffic controls , Road Arboriculture and Highway Lighting
- To study about highway alignment , Road machineries and Construction of different types of Roads
- To study about Railway fixtures , Types of stations , Signalling and Control of movement of trains
- To study about Maintenance of Track and Rapid Transport System of Railways
- To Know about Bridges , Classifications and its Components

## 31042 TRANSPORTATION ENGINEERING

### DETAILED SYLLABUS

Contents: Theory

Unit	Name of the Topic	Hours
I	<p style="text-align: center;"><b><u>HIGHWAY ENGINEERING</u></b></p> <p><b>1.1 INTRODUCTION</b> General – Development of Roads in India - Modes of transportation - Nagpur Plan - Ribbon development - Advantages of Roads - Importance of roads in India - Requirements of an ideal road - Indian Road Congress - Objects of Highway planning - Classifications of Highways.</p> <p><b>1.2 HIGHWAY PAVEMENTS</b> Objectives - Types of Pavement - Flexible and Rigid Pavements - Comparative study of Flexible and Rigid pavements - Factors affecting the design of pavements - Other types of pavements ( Description not reqd. )</p> <p><b>1.3 GEOMETRICAL DESIGN OF HIGHWAYS</b> General - Road structure - Right of way - Land width - Width of formation - Road Camber - Super elevation - Sight distances - Road gradient - Road Curves - Horizontal curves - Vertical curves - Types - Widening of pavement on horizontal curves.</p> <p><b>1.4 TRAFFIC ENGINEERING</b> Objectives - Traffic surveys - Road accidents - Causes of road accidents - Preventive measures - Parking - Methods of parking - Road junctions ( Grade intersections and Grade separators ) - Traffic signals - Advantages - Types of road signs - Expressways.</p> <p><b>1.5 SUB GRADE SOIL</b> Significance - Soil mass as a three phase system - Grain size classification - Atterberg limits - Definition and description - I S Classification of soils - Compaction - Definition - Objects of compaction - Standard Proctor Compaction test - Shear strength - Definition - importance - Direct shear test.</p> <p><b>1.6 ROAD ARBORICULTURE AND LIGHTING</b> Objects of Arboriculture - Selection of trees - Location of trees - Highway lighting - Benefits.</p>	13 Hrs

II	<p style="text-align: center;"><b><u>HIGHWAY ENGINEERING ( Contd. )</u></b></p> <p><b>2.1 HIGHWAY ALIGNMENT AND SURVEYS</b></p> <p>Definition - Principles for ideal highway alignment - Factors affecting highway alignment - Surveys - Engineering surveys - Reconnaissance, Preliminary and Location surveys - Project Report and Drawings - Highway Re-alignment projects.</p> <p><b>2.2 ROAD MACHINERIES</b></p> <p>Excavating equipments - Tractor, Bull dozer, Grader, Scraper, J C B - Compaction equipments - Road roller - Types and description - Equipment for Bituminous road.</p> <p><b>2.3 LOW COST ROADS</b></p> <p>General - Classifications - Earthen road, Gravel road, Water Bound Macadam roads - Construction with sketches - Advantages and disadvantages - Maintenance - Soil stabilization - Methods.</p> <p><b>2.4 BITUMINOUS ROADS</b></p> <p>General - Advantages and disadvantages - Bituminous materials used - Types of Bituminous roads - Surface dressing - Types - Bituminous Concrete - Maintenance of Bituminous roads.</p> <p><b>2.5 CEMENT CONCRETE ROADS</b></p> <p>General - Advantages and disadvantages - Methods of construction of cement concrete roads with sketches - Construction procedure for concrete roads.</p> <p><b>2.6 HILL ROADS</b></p> <p>Factors considered in alignment - Formation of hill roads - Hair pin bends - Retaining and Breast walls.</p>	13 Hrs
----	--	--------

III	<p style="text-align: center;"><b><u>RAILWAY ENGINEERING</u></b></p> <p><b>3.1 INTRODUCTION</b> Introduction to Railways - Classifications of Indian Railways - Rail Gauges - Types - Uniformity in gauges - Loading gauge - Construction gauge.</p> <p><b>3.2 RAILS</b> General - Functions of rails - Requirements of an ideal rail - Types of rail sections - Length of rails - Welding of rails - Wear of rails - Coning of wheels - Hogged rails - Bending of rails - Creep of rails - Causes and prevention of creep.</p> <p><b>3.3 SLEEPERS AND BALLAST</b> Functions of Sleepers - Types of sleepers - Requirements of sleepers - Materials for sleepers - Sleeper density – Ballast- Functions of Ballast - Requirements of ballast - Materials used as ballast.</p> <p><b>3.4 RAIL FASTENINGS AND PLATE LAYING</b> Rail joints - Types - Rail fastenings - Fish plates - Fish bolts - Spikes - Chairs and Keys - Bearing plates - Blocks - Elastic fastenings - Anchors and anti-creepers - Plate laying - Methods of plate laying - PQRS method of relaying.</p> <p><b>3.5 MAINTENANCE OF TRACK</b> Necessity - Maintenance of Track, Bridges and Rolling stock.</p>	13 Hrs
IV	<p style="text-align: center;"><b><u>RAILWAY ENGINEERING ( Contd. )</u></b></p> <p><b>4.1 STATIONS AND YARDS</b> Definition of station - Purpose of railway station - Types of stations - Wayside, Junction and Terminal stations - Platforms - Passenger and Goods platforms - Definition of Yard - Types of yard - Passenger yard, Goods yard, Marshalling yard and Locomotive yards - Level crossings.</p> <p><b>4.2 STATION EQUIPMENTS</b> General - Engine shed - Ash pits - Examination pits - Drop pits - Water columns - Triangles - Turn table - Traversers - Scotch Block - Buffer stops - Fouling marks - Derailing switch - Sand hump - Weigh bridges.</p> <p><b>4.3 POINTS AND CROSSINGS</b> Purpose - Some definitions - Turnouts - Right hand and left hand turnouts - Sleepers laid for points and crossings - Types of switches - Crossings - Types of crossings.</p>	13 Hrs



**REFERENCE:**

1. RANGWALA, "Highway Engineering" , Charotor Publishing House Pvt. Ltd., Edition 2010
2. RANGWALA, "Railway Engineering" , Charotor Publishing House Pvt. Ltd., Edition 2010
3. RANGWALA, "Bridge Engineering" , Charotor Publishing House Pvt. Ltd., Edition 2009
4. S P CHANDOLA, "A Text Book of Transportation Engineering" S Chand & Company Ltd.,
5. G V RAO, "Principles of Transportation & Highway Engineering" Tata McGraw-Hill Publishing Company Ltd.,
6. Madhan Mohan Dass, "Structural Analysis" PHI Learning Pvt. Ltd., New Delhi.

[www.binils.com](http://www.binils.com)



# UNIT- I

## HIGHWAY ENGINEERING

### 1.1 INTRODUCTION

#### 1.1.1 GENERAL

Transportation is the movement of people or goods from one place to another. Transport is important since it enables trade between people, which in turn augments economic growth and fosters civilizations. The transport system comprises of highways or roadways, Railways, water ways and air ways.

Road ways include highways, city roads, village roads, feeder roads and ghat roads. Roadways provide maximum service to one and all. It is possible to provide door to door services only by road.

#### 1.1.2 DEVELOPMENT OF ROADS IN INDIA

Transportation is one of the infrastructures of a country. Transportation helps in economic, industrial, social and cultural development of a country. Transportation is very important for the economic development of any region since commodities produced, like food, clothing, industrial products, medicine need transport at all stages from production to distribution. It is also essential for strategic movement in emergency for defence of the country and to maintain better law and order. Transportation also helps in tourism development.

Road transport is one of the most common modes of transport. Roads in the form of track ways, human pathways etc. were used even from the pre-historic times. Since then many experiments were going on to make the riding safe and comfort. Thus road construction became an inseparable part of many civilizations and empires.

The history of highway engineering gives us an idea about the roads of ancient times. Roads in Rome were constructed in a large scale and it radiated in many directions helping them in military operations. Thus they are considered to be pioneers in road construction.

In India the Mauryan dynasty rulers and Harsha Vardhana took much interest in the development of road system as they were able to appreciate the importance of road in terms of strategic and economical development of country. In the later period the Mughal emperors paid much importance in construction of roads; Patna-Kabul, Delhi-Surat, Delhi-Golconda, Golconda-Bijapur, Bijapur-Ujjain and Surat-Maulipatanam are some of the notable highways developed by them.

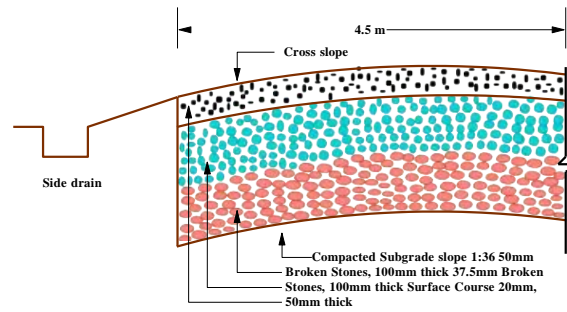

**Figure : 1.1.2.1 British Road**

### **1.1.2.1 BRITISH ROAD**

The British government also gave importance to road construction. The British engineer John Macadam introduced what can be considered as the first scientific road construction method. Stone size is an important element of Macadam surface formation. By empirical observation of many roads, he came to realize that 250 mm layers of well compacted broken angular stone would provide the same strength and stiffness and a better running surface than an expensive pavement made on large stone blocks. Thus he introduced an economical method of road construction.

The mechanical interlock between the individual stone pieces provides strength and stiffness to the course. But the inter particle friction abraded the sharp interlocking faces and partly destroy the effectiveness of the course. This effect was overcome by introducing good quality interstitial finer material to produce a well-graded mix. Such mixes also proved less permeable and easier to compact. A typical cross section of British roads is given in Figure 1.1.2.1.

### **1.1.2.2 MODERN ROADS**

The modern roads by and large follow Macadam's construction method. Use of bituminous concrete and cement concrete are the later developments. Various advanced and cost-effective construction technologies are used. Development of new equipments help in the faster construction of roads. Many easily and locally available materials are tested in the laboratories for their suitability and then used on roads for making economical and durable pavements.

### **1.1.3 MODES OF TRANSPORTATION**

Scope of transportation system has developed very largely. Population of the country is increasing day by day. The life style of people began to change. The need for travel to various places at faster speeds also increased. This increasing demand led to the emergence of other modes of transportation like railways and airways. While the above development in public transport sector was taking place, the development in private transport was at a much faster rate mainly because of its advantages like accessibility, privacy, flexibility, convenience and comfort. This led to the increase in vehicular traffic especially in public road network. Thus road space available was becoming insufficient to meet the growing demand of traffic and congestion started. In addition, chances for accidents also increased. This has led to the increased attention towards control of vehicles so that the transport infrastructure could be used optimally. Various control measures like traffic signals, providing roundabouts and medians, limiting the speed of vehicle at specific zones etc. were implemented.

With the advancement of better roads and efficient control, more and more investments were made in the road sector especially after the world wars. These were large projects requiring large investment. For optimal utilization of funds, one should know the travel pattern, travel behavior and the future economic growth potential of the region. This has led to the emergence of transportation planning and demand management.

### **1.1.4 NAGPUR PLAN**

The British did not pay much attention in developing the new road system and in maintaining the existing roads. They paid special attention only on the roads which served their strategic and economic interest. During the post-war years there arose a great demand for better and more roads to cope with the increased vehicular traffic throughout the country. The Government of India appointed “The Road Development Committee” popularly known as the “Jayakar Committee” in 1927 was a major landmark in the history of road in India. The Committee was emphatic regarding the inadequacy of the Indian road system and urged that further development of the system was desirable for the general welfare of the country and economic growth as a whole. As a sequel to the Jaykar Committee recommendation, The Indian Road Congress came into being in April, 1934, which convened a conference of chief engineers at Nagpur in 1943. It was the first time, at this conference, that the question of road development was considered comprehensively and in a scientific manner. A long term plan,

popularly called the Nagpur Plan envisaged the construction of new roads besides the improvement of some existing ones. The plan classified the roads into four classes:

- i. National Highways
- ii. Provincial or State Highways
- iii. District Roads
- iv. Village Roads

From 1919 to 1947, the provinces remained solely responsible for the construction and maintenance of all roads. Under the new constitution of India, the national highways were made a central subject, and the central government had statutorily taken over the roads classified as national highways, vide the “National Highways Act, 1956”. For the execution of national highway scheme the central government created the roads wing in the department of transport, which as per the suggestion of Nagpur conference was made responsible for co-ordination and control, drafting of standards and specifications, setting priorities, general administration and inspection. Nagpur plan covered the period from 1943 to 1961 and laid the foundation for the functional classification of road network and criteria for road construction and connectivity both in developed and undeveloped area of our country. This was followed by two more 20 year road development plans covering the periods 1961-81 and 1981-2001 popularly known as ‘Bombay Plan’ and ‘Lucknow Plan’, respectively. These plans have served as sound reference framework for the central and the state governments to formulate the further road plan (IRC, 1984) for road development. The government of India changed the development strategy in 1991 by introducing a series of reforms and structural changes with a view to integrating it with the global market and economy. The areas which were traditionally in the domain of the public sector were thrown open to private sector. The rationale was that while the government provides a strong policy support and regulatory leadership, the private sector would bring in dynamism and efficiency in the construction of the road transport system. The above policy serves both social and economic aspects in road construction. In view of these developments “Road Development Plan: Vision 2021” was prepared in 2001 by the Ministry of Road Transport and Highways (MORTH), Government of India.

### **1.1.5 RIBBON DEVELOPMENT:**

Any development that takes place alongside a highway without proper plan and design develops chaotic traffic and pedestrian movements, leading to accidents. This type of linear development is known as ribbon development.

#### **1.1.5.1 DISADVANTAGES OF RIBBON DEVELOPMENT:**

- Ribbon development strangles the road system and creates ugly and undesirable spots where there might have been scenic surroundings.
- Increase in congestion on the highways. The commercial establishments located along the main highway attract heavy two wheeler traffic of the industrial workers going to work in the morning and returning in the evening. The net result is that local traffic, of a predominantly mixed character, claims heavy demand on the road space and gets its major share to the detriment of through traffic emanating from the towns and entering the towns.
- The congestion caused by mixed traffic increases the probability of accidents. The presence of a large number of advertisements and sign boards on roads is an important source of driver distraction leading to numerous accidents.
- Reduces the level of service of the main highway.
- Problem of encroachments.
- Due to ribbon development, widening of highways becomes a difficult task, leading to acquisition of properties at exorbitant cost. If future traffic has to be catered to, it is necessary that adequate control is exercised on linear growth.
- As already pointed out that some of the legislations already holding field discourage ribbon development and in any case unplanned ribbon development.

Considering the above mentioned difficulties in road transport system there should always be a proper plan preferably a master plan for laying new roads and for the improvement of existing road transport system.

### **1.1.6 ADVANTAGES OF ROADS:**

As compared to the railways, the road transport system has definite advantages which can be summarized as follow:

- 1 Road transport is quicker, more convenient and more flexible. It is particularly

good for short distance travel for movement of goods. Motor vehicles can easily collect passengers and goods from anywhere and take them to wherever they want to be dropped.

- 2 Door-to-door collection and delivery are possible in the case of road transport. But in the case of railways, the lines are fixed and the railways do not have the flexibility of the roadways. Passengers and goods will have to be taken to the railway stations.
- 3 Roads are a necessary complement to railways. India is a country of villages and it is only roads which can connect villages and railways can connect towns. The railway stations will have to be properly served by a network of feeder roads. Only through these roads the railways can receive their passengers and goods. If railways are essential for the movement of goods and people for long distances, road transport is essential for such movement for short distances. Roads and railways are, therefore, not competitive but complementary to each other.
- 4 Road transport is of particular advantage to the farmers. Good roads help the farmers to move their products, particularly the perishable products; like vegetables, quickly to the market and towns. Only by developing the road system, the farmer can be assured of a steady market for his products. It is the road system which brings the villagers into contact with the towns and to expose them to the new ideas and the new systems.
- 5 Roads are highly significant for the defense of the country. For the movement of troops, tanks, armored cars, and field guns etc. roads are essential. The great importance given to the construction of border roads to facilitate the movement of troops for the protection of the northern borders.
- 6 It is easy and cheap to construct and maintain roads compared to other mode of transport.
- 7 Roads can negotiate high gradients and sharp turns which railways cannot do. As such, roads can be constructed in hilly areas also.

Due to above-mentioned advantages, the road transport has become very popular and its share is constantly increasing.

### **1.1.7 IMPORTANCE OF ROADS IN INDIA:**

Connectivity provided by roads is perhaps the single most important determinant of well-being and the quality of life of people living in an urban area. The objective of the innumerable government programmes aimed at rural development, employment generation and local industrialization to a large extent due to the construction and connectivity of the road transport system. There is a considerable body of evidence that demonstrates that the lack of links between rural roads with other state and national highway result in less economic growth that leads to poverty and poor quality of life. Road investment contributed directly to the growth of agricultural output, increased use of fertilizer and establishment of commercial banks.

### **1.1.8. REQUIREMENTS OF AN IDEAL ROAD:**

The important points to be kept in mind for the design of highways of various types are as follows:

(i) It should be free from being submerged during floods and thus should be available for safe movement of traffic at all times.

(ii) It should be provided with easy gradient.

(iii) It should contain intelligently erected traffic signs and should make sufficient provisions for the safety of pedestrians and vehicles.

(iv) It should grant various amenities to road users such as grass verges, sufficient lighting, watering and fuelling places at regular intervals, shady avenues, parking facilities in city areas, etc.

(v) It should possess good alignment, directness and visibility.

(vi) The curves along the road should be properly designed and they should be free from blind corners.

(vii) The formation of road, either natural or prepared, should be stable enough to carry the foundation and traffic load.

(viii) The foundation depth should be adequate for effectively distributing traffic load over a sufficient area of formation to keep the intensity of load within the safe permissible limits of the soil.

(ix) The road surface should be suitable for the general character of traffic and it should possess characteristics such as:

- (a) economical in construction and maintenance costs,
  - (b) even and smooth, but not slippery,
  - (c) hard, durable with uniform wear,
  - (d) neither dusty nor muddy and easy for cleaning and repairing,
  - (e) noiseless especially near hospitals, nursing homes and public institutions, etc.,
  - (f) offering the least resistance to traffic, etc.
- (x) The surface of road should be impervious and impermeable to rain water.
  - (xi) The width of road should be sufficient
  - (xii) good drainage system to drain the water from the road surface

### **1.1.9 INDIAN ROAD CONGRESS**

The origin of Indian Road Congress (IRC) the apex body of road sector engineers and professionals in the country was set up under the Chairmanship of M.R. Jayakker in 1927 by the then Government of India which recommended periodic road conferences to discuss the issues related to road construction, maintenance and development. This forum helped in sharing of knowledge and pooling of experience on the entire subjects of road construction and maintenance, finance, taxation etc.,

### **1.1.10 OBJECTS OF HIGHWAY PLANNING:**

Following are the objects or purposes of highway planning:

- (i) To assist the general planner for serving adequately whatever transportation demand is created by population growth, economic development and technological change.
- (ii) To create awareness of unforeseen events, conditions, changed policies and other current developments.
- (iii) To indicate the analysis for the establishment of financial and management policies required to implement sound decisions.
- (iv) To make optimum use of the existing conditions for working towards improvement so as to meet probable future requirements
- (v) To prepare a plan in such a way that traffic operations are carried out efficiently and safely on the highways.



(vi) To provide factual analyses leading to the determination of required physical development of the highway, road and street network.

### **1.1.11 CLASSIFICATION OF HIGHWAYS**

#### **1.1.11.1 ROADS CLASSIFICATION CRITERIA**

Apart from the classification given by the different plans, roads were also classified based on some other criteria. They are given in detail below.

##### **1. BASED ON USAGE**

This classification is based on whether the roads can be used during different seasons of the year.

- i. All-weather roads: Those roads which are negotiable during all weathers, except at major river crossings where interruption of traffic is permissible up to a certain extent are called all weather roads.
- ii. Fair-weather roads: Roads which are negotiable only during fair weather are called fair weather roads.

##### **2. BASED ON CARRIAGE WAY**

This classification is based on the type of the carriage way or the road pavement.

- i. Paved roads with hard surface: If they are provided with a hard pavement course such roads are called paved roads.(eg: stones, Water bound macadam ( WBM), Bituminous macadam (BM), concrete roads.
- ii. Unpaved roads: Roads which are not provided with a hard course of at least a WBM layer they is called unpaved roads. Thus earth and gravel roads come under this category.

### **3. CLASSIFICATION OF ROADS AS PER I.R.C (INDIAN ROAD CONGRESS)**

Based on location and function, the Nagpur plan classifies the roads as

- a) National Highways (NH)
- b) State Highways (SH)
- c) Major district Roads (MDR)
- d) Other district roads (ODR) and
- e) Village Rods

- a) **National Highways (NH):** These are the main highways which connects ports, foreign highways, capital cities of large states and large industrial and tourist centre including roads of military importance. They are financed and constructed by central government. All the national highways are assigned the respective numbers. The highway Vijayawada and Pune, through Hyderabad is NH9. Nagpur – Hyderabad – Bangalore road denoted as NH7.
- b) **State Highways (SH):** These are important roads of a state. The state highways connect national highways of adjacent state, district headquarters and important cities within the state. They are financed and constructed by the State government
- c) **Major District Roads (MDR):** These are important roads within district serving areas of production and market and connecting the main highways of a district.
- d) **Other District Roads (ODR):** These roads are serving rural areas of production and connect them with market centre, Taluk headquarters, and other main roads.
- e) **Village roads:** These are the roads connecting villages or group of villages with each other to the nearest road of a higher category. They are financed and constructed by panchayaths with the help of zilla parishads and State governments.

#### 1.1.11.2 MODIFIED CLASSIFICATION OF ROAD SYSTEM BY THIRD ROAD DEVELOPMENT PLAN (1981 – 2001)

The roads in the country are now classified in to three classes

- 1.Primary system
- 2.Secondary system
- 3.Tertiarysystem

##### 1. Primary system consists of two categories of roads

- Express ways and
- National Highways (NH)

Express ways are separated class of highways with superior facilities and design standards meant for very high volume traffic. These permit only fast moving vehicles.

##### 2. The secondary system consists

- State highways (SH) and
- Major District Roads

### **3. Tertiary system consists of**

- Other District Roads (ODR) and
- Village Roads

#### **1.1.11.3 CLASSIFICATION OF URBAN ROADS**

The urban roads are classified as

- Arterial Roads
- Sub–arterial roads
- Collector streets and
- Local streets

Arterial and sub arterial roads are the streets primarily for through traffic.

[www.binils.com](http://www.binils.com)

## **1.2 HIGHWAY PAVEMENTS**

### **1.2.1 OBJECTIVES**

A highway pavement is a structure consisting of superimposed layers of processed materials above the natural soil known as 'sub-grade'. The pavement's primary function is to distribute the applied vehicle loads to the sub-grade. The pavement structure should be able to provide a surface of acceptable riding quality, adequate skid resistance, favourable light reflecting characteristics and low noise pollution. The ultimate aim is to ensure that the transmitted stresses due to the vehicle load are sufficiently reduced, so that they will not exceed bearing capacity of the sub- grade. Two types of pavements are generally recognized as serving this purpose, namely flexible pavements and rigid pavements. Improper design of pavements leads to early failure of pavements affecting the riding quality.

### **1.2.2 REQUIREMENTS OF AN IDEAL PAVEMENT**

**An ideal pavement should meet the following requirements:**

- Sufficient width and thickness to distribute the wheel load stresses to a safe value on the sub-grade soil
- Structurally strong to withstand all types of stresses imposed upon it
- Adequate coefficient of friction to prevent skidding of vehicles
- Smooth surface to provide comfort to road users even at high speed
- Produce least noise from moving vehicles
- Dust proof surface so that traffic safety is not impaired by reducing visibility
- Impervious surface, so that sub-grade soil is well protected
- Long life with low maintenance cost.

### **1.2.3 TYPES OF PAVEMENTS:**

The pavements can be classified based on the structural performance into two, flexible pavements and rigid pavements. In flexible pavements, wheel loads are transferred by grain-to-grain contact of the aggregate through the granular structure. The flexible pavement, having less flexural strength, acts like a flexible sheet (e.g. bituminous road). On the contrary, in rigid pavements, wheel loads are transferred to sub-grade soil by flexural strength of the pavement and the pavement acts like a rigid plate (e.g. Cement concrete roads). In addition to these, composite pavements are also available. A thin layer of flexible pavement over rigid pavement is

an ideal pavement with most desirable characteristics. However, such pavements are rarely used in new construction because of high cost and complex analysis requirement.

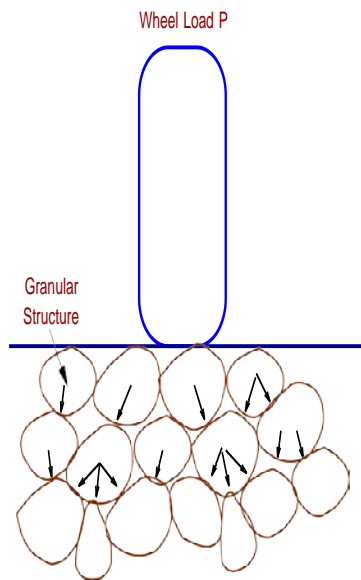

[www.binils.com](http://www.binils.com)  
1.2.3 Load transfer in granular structure

## 1.2.4 FLEXIBLE PAVEMENTS AND RIGID PAVEMENTS

### 1.2.4.1 FLEXIBLE PAVEMENT

Flexible pavements will transmit wheel load stresses to the lower layers by grain-to-grain transfer through the points of contact in the granular structure (see Figure). The wheel load acting on the pavement will be distributed to a wider area, and the stress decreases with the depth. Taking advantage of this stress distribution characteristic, flexible pavements normally has many layers. Hence, the design of flexible pavement uses the concept of layered system. Based on this, flexible pavement may be constructed in a number of layers and the top layer has to be of best quality to sustain maximum compressive stress, in addition to wear and tear. The lower layers will experience lesser magnitude of stress and low quality material can be used. Flexible pavements are constructed using bituminous materials. These can be either in the form of surface treatments (such as bituminous surface treatments generally found on low volume roads) or, asphalt concrete surface courses (generally used on high volume roads such as national

highways). Flexible pavement layers reflect the deformation of the lower layers on to the surface layer (e.g., if there is any undulation in sub-grade then it will be transferred to the surface layer). In the case of flexible pavement, the design is based on overall performance of flexible pavement, and the stresses produced should be kept well below the allowable stresses of each pavement layer.

Pavement structure consists of the prepared subgrade and the pavement component layers such as sub-base, base and surface course. The stability or the structural capacity of the pavement depends upon the pavement layer system including the subgrade. However, the road users are concerned about the riding quality, safety and other performance aspects of the road pavement rather than the pavement structure, design life etc. Hence, it is important to ensure the above requirements also while designing a pavement. The flexible pavements are constructed as a multi-layer system consisting of typical component layers, namely sub-base, base course, and surface course.

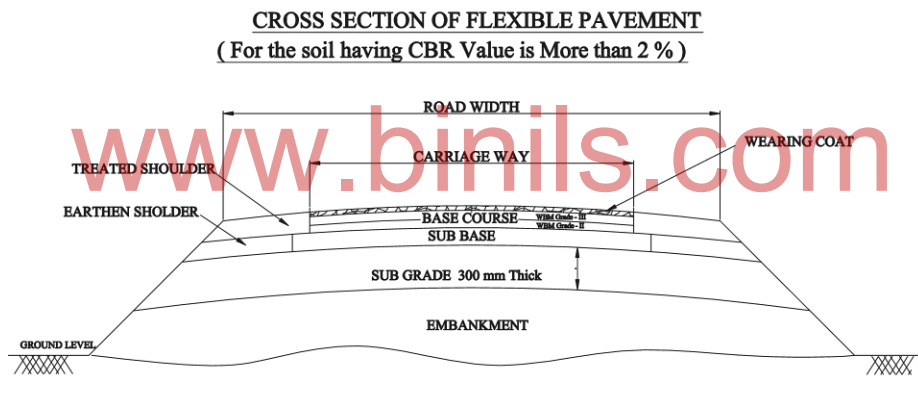

#### 1.2.4.1 Flexible pavements consist of a number of layers.

#### 1.2.4.2 RIGID PAVEMENTS:

Rigid pavements have sufficient flexural strength to transmit the wheel load stresses to a wider area below. A typical cross section of the rigid pavement is shown in Figure. Compared to flexible pavement, rigid pavements are placed either directly on the prepared sub-grade or on a single layer of granular or stabilized material. Since there is only one layer of material between the concrete and the sub-grade, this layer can be called as base or sub-base course.

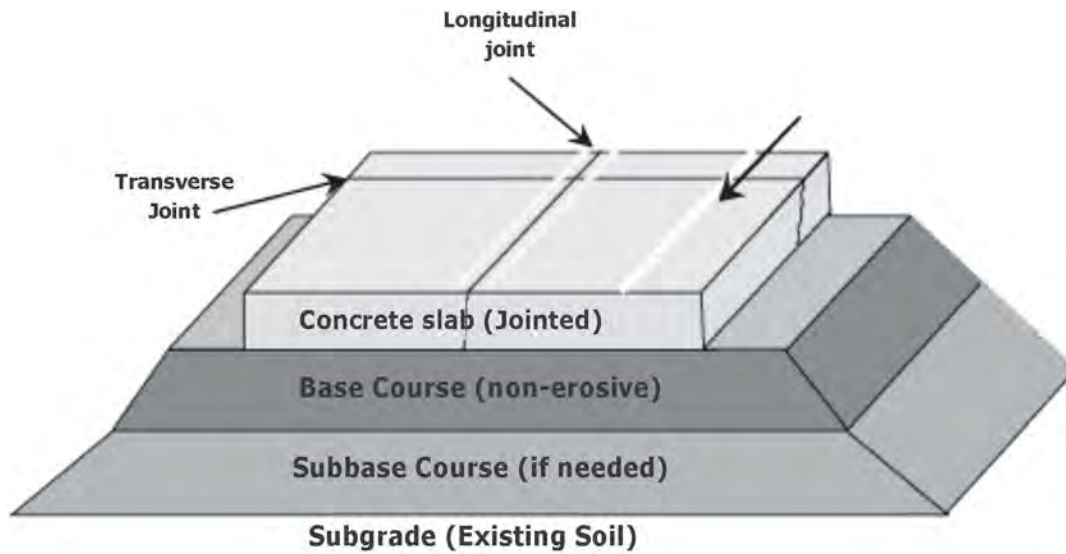

#### 1.2.4.2. RIGID PAVEMENT

In rigid pavement, load is distributed by the slab action, and the pavement behaves like an elastic plate resting on a viscous medium. Rigid pavements are constructed by Portland cement concrete (PCC) and should be analyzed by plate theory instead of layer theory, assuming an elastic plate resting on viscous foundation. Plate theory is a simplified version of layer theory that assumes the concrete slab as a medium thick plate which is plane before loading and to remain plane after loading. Bending of the slab due to wheel load and temperature variation and the resulting tensile and flexural stress.

#### 1.2.5 COMPARISON OF FLEXIBLE AND RIGID PAVEMENT

Flexible Pavements	Rigid Pavements
Deformation in the <b>sub-grade</b> is transferred to the upper layers	Deformation in the <b>subgrade</b> is not transferred to subsequent layers
Design is based on <b>load distributing characteristics</b> of the component layers	Design is based on <b>flexural strength</b> or slab action
Have <b>low</b> flexural strength	Have <b>high</b> flexural strength
Load is transferred by <b>grain to grain</b>	<b>No such phenomenon of grain to grain</b>

<b>contact</b>	load transfer exists
Have <b>low</b> construction cost but repairing cost is <b>high</b>	Have <b>low</b> repairing cost but construction cost is <b>high</b>
Have <b>low</b> life span (High Maintenance Cost)	Life span is <b>more</b> as compare to flexible (Low Maintenance Cost)
Surfacing <b>cannot be laid directly</b> on the sub grade but a sub base is needed	Surfacing <b>can be directly laid</b> on the sub grade
<b>No thermal stresses</b> are induced as the pavement have the ability to contract and expand freely	<b>Thermal stresses are more</b> vulnerable to be induced as the ability to contract and expand is very less in concrete
Expansion joints are <b>not needed</b>	Expansion joints <b>are needed</b>
Strength of the road is <b>highly dependent</b> on the strength of the sub grade	Strength of the road is <b>less dependent</b> on the strength of the sub grade
Rolling of the surfacing is <b>needed</b>	Rolling of the surfacing <b>in not needed</b>
Road can be used for traffic <b>within 24 hours</b>	Road <b>cannot be used until 14 days of curing</b>
Force of <b>friction is less</b> Deformation in the sub grade is not transferred to the upper layers.	Force of <b>friction is high</b>
<b>Damaged</b> by Oils and Certain Chemicals	<b>No Damage</b> by Oils and Greases

### 1.2.6 OTHER TYPES OF PAVEMENTS :

The following types of pavements are based on the material used in the road construction.

- a) Cement concrete pavement
- b) PSC pavement
- c) WBM pavement
- d) Bituminous pavement



### **1.2.7 FACTORS AFFECTING DESIGN OF PAVEMENT**

There are many factors that affect pavement design which can be classified into four categories as traffic and loading, structural models, material characterization, environment.

1. Volume of Traffic and intensity of vehicular loading
2. Contact area and contact pressure between wheel and pavement surface
3. Axle configuration such as single axle, multiple axle etc.,
4. Nature of moving loads of vehicle: ( Fast moving/slow moving) Faster the moving the stress will be more and vice versa.
5. Repetition of loads: The influence of traffic on pavement not only depending upon the magnitude of the wheel load and also on the frequency of the load application.
6. Nature of structural model of pavement
7. Quality of material used in the construction
8. Weathering conditions such as temperature, rainfall and other environmental factors in the stretch of the road

[www.binils.com](http://www.binils.com)

## 1.3 GEOMETRICAL DESIGN OF HIGHWAY

### 1.3.1 ROAD STRUCTURE:

Road structure consists of the following components as shown in the fig.1.3.2.

- i. Sub soil
- ii. Sub grade
- iii. Base course
- iv. Wearing course or Surface course
- v. Berm

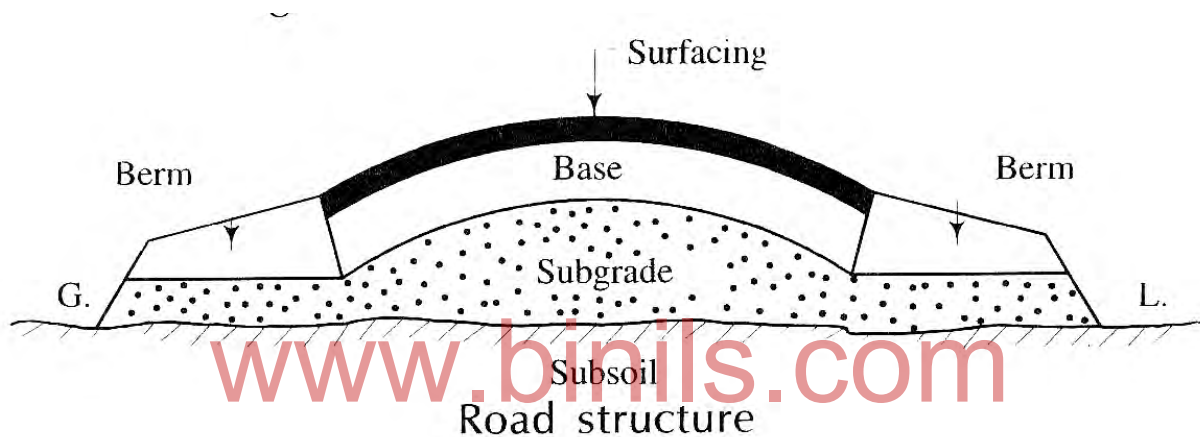

1.3.1 Cross sections of road structures

#### i) SUB SOIL:

This is the natural or prepared soil on which a road has to be formed which should be strong and stable to carry the road traffic and weight of road construction.

#### ii) SUB GRADE:

The sub grade functions as a support to road surface and serves as a foundation. The life of road primarily depends on the stability and dryness of sub grade. Therefore considerable attention should be paid in the preparation of the sub grade.

#### iii) BASE COURSE:

Base course is a layer made of granular material such as broken granite stone, natural gravel,

and boulder stone. It is a layer immediately under the wearing course. It is an important structural part of the road. It should be strong enough to bear the loads of the traffic. The material in a base course must be of extremely high quality. It must be well compacted.

**FUNCTIONS OF BASE COURSE:**

- a) It reduces the traffic stresses on the sub grade and protects it.
- b) Acts as a working platform for the construction of upper pavement layers.
- c) Acts as a drainage layer by protecting the sub grade from wetting up.
- d) Intercept the upward movement of water by capillary action.
- e) It acts as a separating layer between subgrade and base course.

**iv) WEARING COURSE OR SURFACE COURSE:**

Wearing course is the top most layer of a road which is in direct contact with the traffic. The purpose of the wearing course is to give a dense smooth riding surface with flexibility. It resists the pressure exerted by tyres and withstands wear and tear due to the traffic. It acts as a water tight layer and prevents percolation of water.

**1.3.2 RIGHT OF WAY**

Right of way is the area of land acquired and reserved along its alignment for construction and development of a highway is known as right of way.

**1.3.2.1 LAND WIDTH:**

A minimum land width is prescribed for different categories of road. The below table gives the minimum width of right of way for different categories of road.

No.	Type of road	Plain and rolling terrain				Mountainous and steep terrain	
		Open areas		Built-up areas		Open areas	Built-up areas
		Normal m	Range m	Normal m	Range m	Normal m	Normal m
1	NH and SH	45	30-60	30	30-60	24	20
2	MDR	25	25-30	20	15-25	18	15
3	ODR	15	15-25	15	15-20	15	12
4	VR	12	12-18	10	10-15	9	9

**1.3.2 Requirement of right of way**

There are chances of developments along its route and when it becomes necessary to have the

widening of road in future; it proves to be difficult and costly to acquire such developed lands along the boundary of road. Hence the appropriate width of land has to be acquired in the initial stage so that the road can be widened without serious difficulties when the occasion demands in future. The rights of ownership of road land are vested with the highway authority.

As a further precaution, restrictions are put up on the construction activities along the road and for this purpose, building lines and control lines are decided at suitable distance from the road boundary.

The owner of land along highway route has to leave a certain set back or margin from road boundary and he can construct the building up to that line only in his plot. This line is known as building line.

A further set back in the form of control line has to be maintained by the private land owners along the highway route and the development between the portion covered by the building line and control line is restricted by the concerned highway authority.

The right of way mainly depends on the importance of road and it is decided in such a way that the following components of road are suitably accommodated:

- (i) availability of funds;
- (ii) cost of acquisition of lands;
- (iii) drainage systems;
- (iv) height of embankment or depth of cutting;
- (v) side slopes of embankment or cutting;
- (vi) visibility considerations on curves;
- (vii) width of formation;
- (viii) width of land required for future development; etc.

### 1.3.3 WIDTH OF FORMATION:

The width of pavement or carriage way depends on the width of traffic lane and number of lanes. The carriage way intended for one line of traffic movement may be called as a traffic lane. The lane width is determined on the basis of the width of vehicle and the minimum side clearance provided for the safety. When the side clearance is increased there is an increase in speed of the vehicles and hence in increase in the capacity of the pavement. A width of 3.75 m is considered desirable for a road having single lane for vehicles of maximum width 2.44 m. For pavement having two or more lanes, width of 3.5 m per lane is sufficient.

### WIDTHS OF FORMATION

No.	Type of roadway	Formation width in m	
		Plain and rolling terrain	Mountainous and steep terrain
1	National and State Highways		
	Single lane	12.00	6.25
	Two lanes	12.00	8.80
2	Major district roads		
	Single lane	9.00	4.75
	Two lanes	9.00	—
3	Other district roads		
	Single lane	7.50	4.75
	Two lanes	9.00	—
4	Village roads		
	Single lane	7.50	4.00

Table: 1.3.3 Road Classification and dimensions

www.binils.com

Class of Road	Width of the Carriage Way
(i) Single lane	3.75m
(ii) Two lanes, without raised kerbs	7.0 m
(iii) Two lanes, with raised kerbs	7.5 m
(iv) Intermediate carriage way	5.5 m
(v) Multi lane pavement	3.5 m per lane

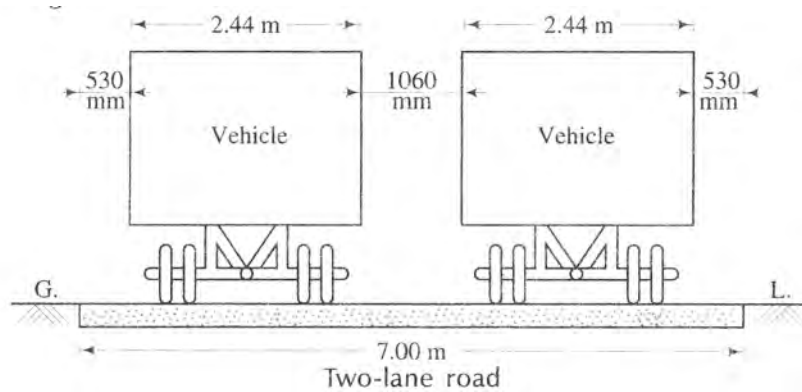
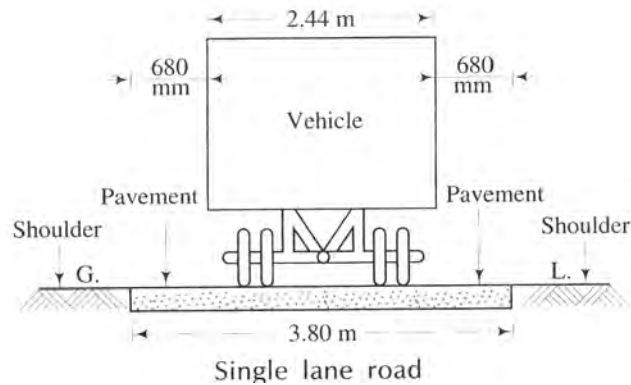

1.3.3 (a) Single and double lane Roadway

[www.binils.com](http://www.binils.com)

### 1.3.3.1 SHOULDERS:

Shoulders are provided along the road edge to serve as an emergency lane for vehicles to be taken out of the pavement. These also act as service lanes for vehicles that have broken down. The minimum shoulder width recommended by the IRC is 2.5 m. The shoulders should have sufficient strength to support loaded even in wet weather. The surface of the shoulder should be rougher than the traffic lanes so that the vehicles are discouraged to use the shoulder as a regular traffic lane.

### 1.3.3.2. CROSS SECTIONS OF ROADS:

The following figures shows the cross-section of road in embankment, cross-section of road in cutting, the typical cross-section of two-lane NH or SH in rural area , the typical cross-section of two-lane city road in Built up area

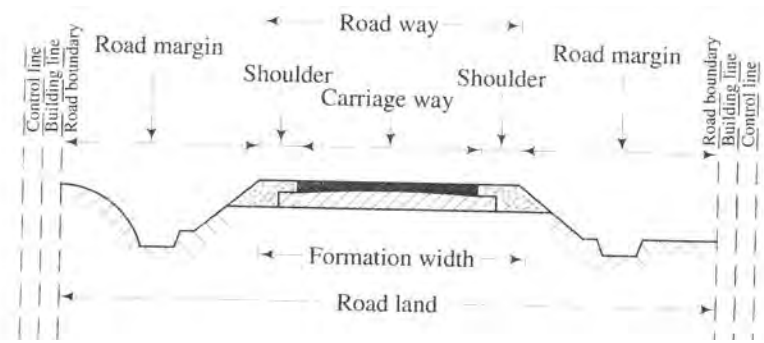

1.3.3.2 (a) Cross section of road in cutting

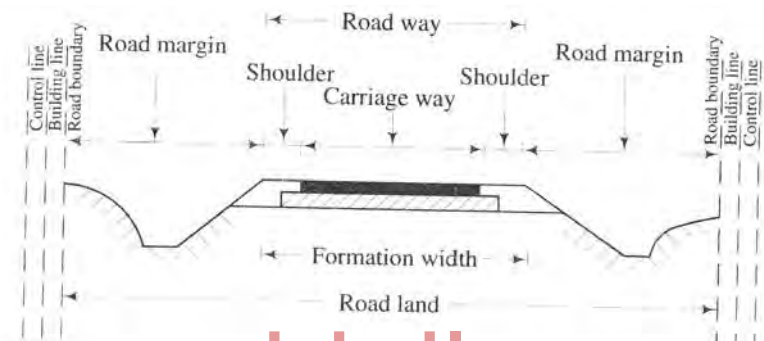

[www.binils.com](http://www.binils.com)

1.3.3.2.(b) Cross section of road in embankment

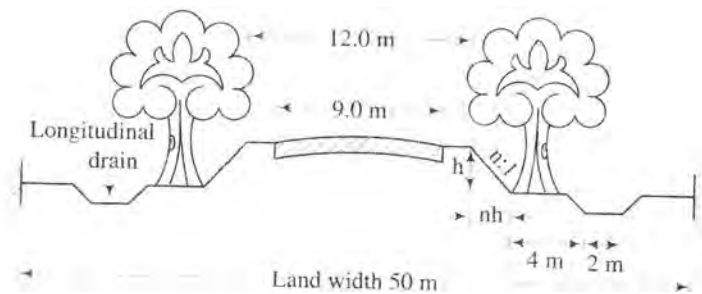

1.3.3.2 (c) Cross section of two lane national highway

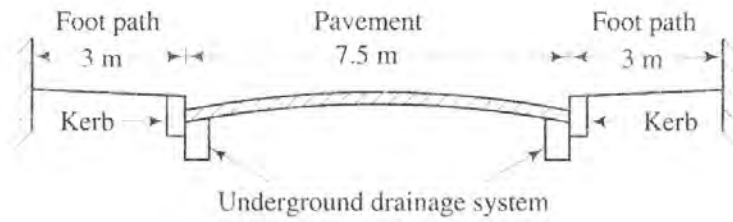

1.3.3.2 (d) Cross sections of two lane road in built-up area

The carriage way intended for one line of traffic movement may be called a traffic lane. The pavement may be of single lane, Two lane or multilane.

### 1.3.4 ROAD CAMBER:

Camber is the cross slope provided across the road to raise middle of the road surface to drain off rain water from road surface. The camber given is either a parabolic, elliptic or straight line shape in the cross section.

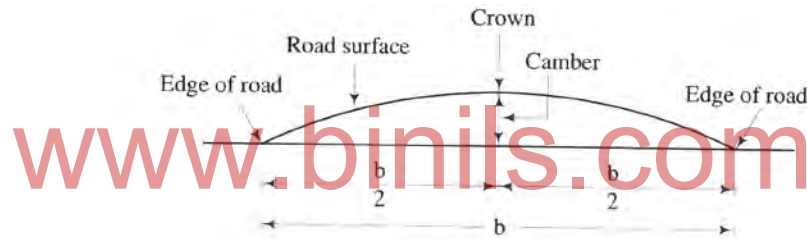

1.3.4 Camber or cross fall of road surface

The objectives of providing camber are

- (i) Surface protection of roads especially for grave land bituminous roads
- (ii) Sub-grade protection by proper drainage
- (iii) Quick drying of pavement which in turn increases safety.

Camber is measured in 1 in n or n % (eg. In 1 in 50 or 2%) and the value depends on the **type of the pavement and the amount of rainfall.**

Table: 1.3.4 IRC Values for camber

Surface type	Heavy rain	Light rain
Concrete/Bituminous	2 %	1.7 %
Gravel/WBM	3 %	2.5 %
Earthen	4 %	3.0 %



### 1.3.5 SUPERELEVATION

In order to counteract the effect of centrifugal force and to reduce the tendency of the vehicle to overturn or skid, the outer edge of the pavement is raised with respect to inner edge, by providing a transverse slope throughout the length of the horizontal curve. This transverse inclination to the pavement surface is known as super elevation or cant or banking. The super elevation “e” is expressed as the ratio of the height of outer edge with respect to the horizontal width.

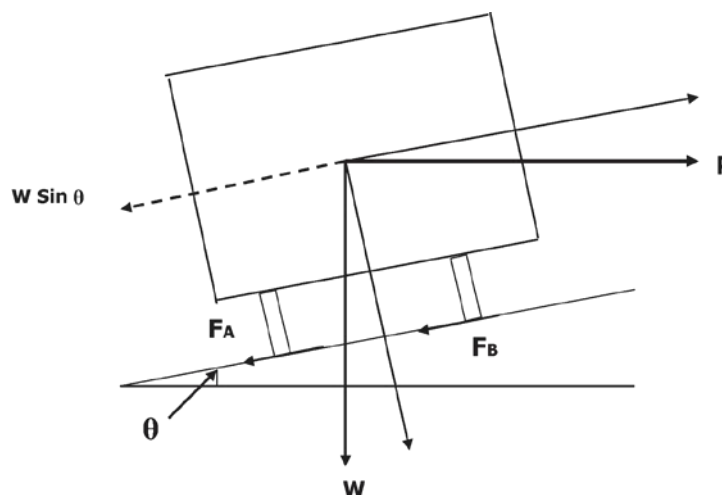

Super elevation is provided to counteract centrifugal force on moving vehicles at horizontal curves and it is calculated from the following formula:

$$e = \frac{v^2}{225 R}$$

where, e = super elevation (%)

v = speed in km/hr

R = radius of curve in meters

Super elevation obtained from the above expression should, however be kept within limit mentioned below:

Plain terrain	- 7 %
Snow bound area	- 7 %
Hilly area but not snow bound	- 10 %

### 1.3.6 SIGHT DISTANCE

The safe and efficient operation of vehicles on the road depends very much on the visibility of the road ahead of the driver. Thus the geometric design of the road should be done such that any obstruction on the road length could be visible to the driver from some safe distance ahead so that the driver can stop the vehicle before the obstruction. This distance is said to be the sight distance.

### 1.3.6.1 TYPES OF SIGHT DISTANCE

Sight distance available from a point is the actual distance along the road surface, over which a driver from a specified height above the carriage way has visibility of stationary or moving objects. Three sight distance situations are considered for design:

#### 1.3.6.1.1 STOPPING SIGHT DISTANCE (SSD) OR THE ABSOLUTE MINIMUM SIGHT DISTANCE

Stopping sight distance (SSD) is the minimum sight distance available on a highway at any spot having sufficient length to enable the driver to stop a vehicle traveling at design speed, safely without collision with any other obstruction.

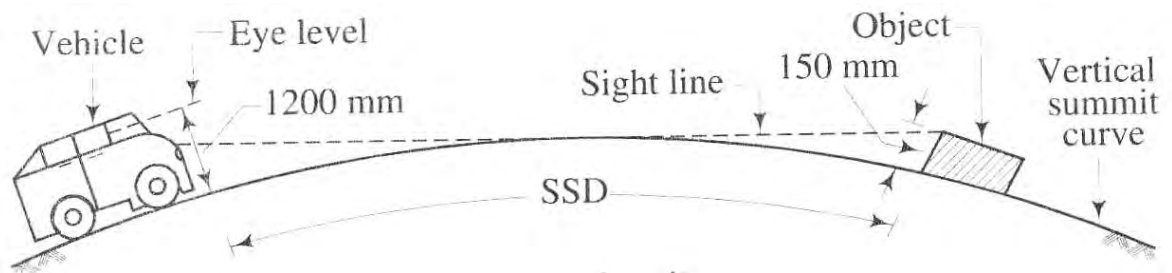

1.3.6.1.1 Stopping Sight Distance

#### 1.3.6.1.2. INTERMEDIATE SIGHT DISTANCE (ISD)

It is defined as twice SSD

#### 1.3.6.1.3. OVERTAKING SIGHT DISTANCE (OSD) FOR SAFE OVERTAKING OPERATION

The overtaking sight distance is the minimum distance open to the vision of the driver of a vehicle intending to overtake the slow vehicle ahead safely against the traffic in the opposite direction. The overtaking sight distance or passing sight distance is measured along the center line of the road over which a driver with his eye level 1.2 m above the road surface can see the top of an object 1.2 m above the road surface.

#### 1.3.6.1.4. HEAD LIGHT SIGHT DISTANCE

It is the distance visible to a driver during night driving under the illumination of head lights.

#### 1.3.6.1.5. SAFE SIGHT DISTANCE TO ENTER INTO AN INTERSECTION.

The most important consideration in all these is that at all times the driver traveling at the design speed of the highway must have sufficient carriageway distance within his line of vision to allow him to stop his vehicle before colliding with a slowly moving or stationary object appearing suddenly in his own traffic lane.

The computation of sight distance depends on:

1. Reaction time of the driver
2. Speed of the vehicle
3. Efficiency of brakes
4. Frictional resistance between the tyre and the road
5. Gradient of the road.

### **1.3.7 ROAD GRADIENT**

Gradient is the rate of rise or fall along the length of the road with respect to the horizontal. While aligning a highway, the gradient is decided for designing the vertical curve. Before finalizing the gradients, the construction cost, vehicular operation cost and the practical problems in the site has to be considered. Usually steep gradients are avoided as far as possible because of the difficulty in climbing which also increase the construction cost. More about gradients are discussed below.

#### **1.3.7.1 EFFECT OF GRADIENT:**

The effect of long steep gradient on the vehicular speed is considerable. This is particularly important in roads where the proportion of heavy vehicles is significant. Due to restrictive sight distance at uphill gradients the speed of traffic is often controlled by these heavy vehicles. As a result, not only the operating costs of the vehicles are increased, but also capacity of the roads will have to be reduced. Further, due to high differential speed between heavy and light vehicles, and between uphill and downhill gradients, accidents abound in gradients.

Ruling gradient, limiting gradient, exceptional gradient and minimum gradient are some types of gradients.

The **ruling gradient** or the design gradient is the maximum gradient with which the designer attempts to design the vertical profile of the road. This depends on the terrain, length of the grade, speed, pulling power of the vehicle and the presence of the horizontal curve.

This gradient is adopted when the ruling gradient results in enormous increase in cost of construction. On rolling terrain and hilly terrain it may be frequently necessary to adopt **limiting gradient**. But the length of the limiting gradient stretches should be limited and must be sandwiched by either straight roads or easier grades.

**Exceptional gradient** are very steeper gradients given at unavoidable situations. They should be limited for short stretches not exceeding about 100 metres at a stretch. In mountainous and steep terrain, successive exceptional gradients must be separated by a minimum 100 metre length gentler gradient. At hairpin bends, the gradient is restricted to 2.5%.

IRC Specifications of different gradients for different roads are as follows.

Table: 1.3.7.1 Gradients for different Terrains

Terrain	Ruling	Limiting	Exceptional
Plain/Rolling	3.3	5.0	6.7
Hilly	5.0	6.0	7.0
Steep	6.0	7.0	8.0

### 1.3.8 ROAD CURVES

When two straight stretches of the road intersect at a point, a smooth curve is introduced connecting the straight stretches to facilitate easy, comfortable, and speedy and safety passage.

There are two types of curve based on the position of the curve in the highways. They are

a) **Horizontal curves**

b) **Vertical curves**

#### 1.3.8.1 HORIZONTAL CURVES

A horizontal highway curve is a curve **in plan** (horizontally situated) to provide change in direction to the central line of road. When a vehicle traverses a horizontal curve, the centrifugal force acts horizontally outwards through the centre of gravity of the vehicle.

The centrifugal force development depends on the radius of the horizontal curve and the speed of the vehicle negotiating the curve. This centrifugal force is counteracted by the transverse frictional resistance developed between the tyres and the pavement which enables the vehicle to change the direction along the curve smoothly with greater stability of the vehicle.

The centrifugal force acting on a vehicle negotiating a horizontal curve has two effects: (i) Tendency to over turn the vehicle about the outer wheel and (ii) Tendency to skid the vehicle laterally.

#### 1.3.8.2 MINIMUM RADIUS OF HORIZONTAL CURVES:

A horizontal curve consists of a circular portion raised on the outer edge. Various design elements of a horizontal curve include radius (R), super elevation (e), transition curve, widening and sight distance. For the various design speeds, suggested values of R and e are so selected that both fall within the prescribed limits as given.

(i) Minimum radius of horizontal curve can be determined from the formula :

$$R = \frac{v^2}{127(e + f)}$$

where  $v$  = speed in km/hr

$R$  = radius in meters

$e$  = super elevation (%)

$f$  = coefficient of side friction (= 0.15 as per IRC).

**Table: 1.3.8.2 Minimum Radii of Horizontal Curves as per IRC**

Road Category	Plain Terrain		Rolling Terrain		Mountainous Terrain				Steep Terrain			
					Areas not affected by snow		Areas affected by snow		Areas not affected by snow		Areas affected by snow	
	Ruling Minimum	Absolute Minimum	Ruling Minimum	Absolute Minimum	Ruling Minimum	Absolute Minimum	Ruling Minimum	Absolute Minimum	Ruling Minimum	Absolute Minimum	Ruling Minimum	Absolute Minimum
Rural Roads (OD and VR)	90	60	60	45	20	14	23	15	20	14	23	15

A transition curve has a radius which decreases from infinity at the tangent point to a designed radius of the circular curve .

### 1.3.8.3 WIDENING OF PAVEMENT AT HORIZONTAL CURVES:

At sharp horizontal curve, it is necessary to widen the carriageway to facilitate safe passage of vehicles. The extra width to be provided to horizontal curve is given in Table 1.3.8.3 The widening should be effected by increasing the width at an approximately uniform rate along the transition curve. The extra width should be continued over the full length of the circular curve.

The widening should be done on both sides of the carriageway, except that on hill roads it will be preferable if the entire widening is done only on the inner side of the curve. Similarly, the widening should be provided only on the inside when the curve is plain circular and has no transition.

On curves in Plain and Rolling Terrain, having no transition (i.e Curve radius (Rc), widening should be achieved in the same way as the superelevation i.e. two-third being attained on the straight section before start of the curve and one-third on the curve.

**Table : 1.3.8.3 Widening of Pavement at Curve (IRC SP : 20 - 2002, Page No. 39)**

Radius of Curve (m)	Upto 20	21-60	Above 60
Extra Widening for 3.75 m Wide Single Lane Carriageway. (m)	0.9	0.6	Nil

**1.3.8.4 SET BACK DISTANCE (M) AT HORIZONTAL CURVES**

The clearance distance required from the centre line of a horizontal curve to an obstruction on the inner side of the curve to provide adequate sight distance is known as set back distance. It depends upon the following factors:

- (a) Required sight distance, S
- (b) Radius of horizontal curve, R
- (c) Length of the curve, Lc which may be greater than S

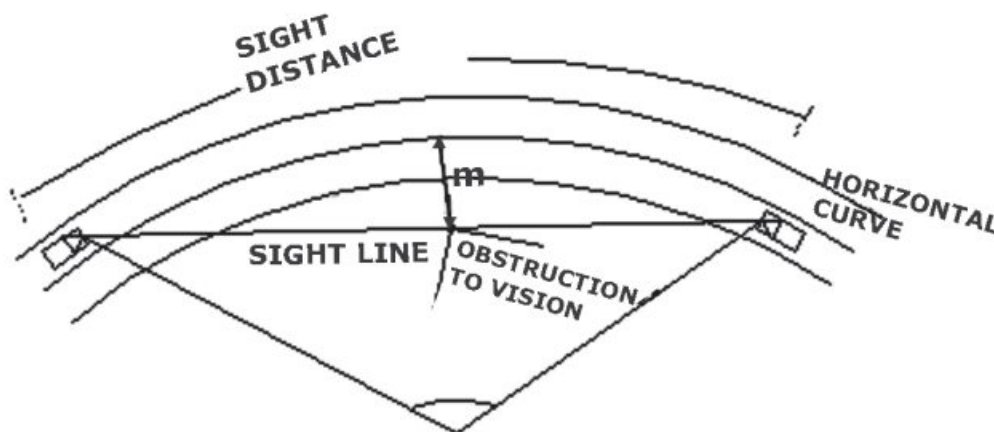

**1.3.8.4 Set-back Distance at Horizontal Curves**

**Table: 1.3.8.4 IRC Recommended Setback Distance for single lane carriageway**

Radius of circular curve (m)	Set- back distance (m)				
	S=20m (v=20 kph)	S=25m (v=25kmph)	S=30m (v=30kmph)	S=45m (v=40kmph)	S=60m (v=50kmph)
14	3.4	-	-	-	-
15	3.2	-	-	-	-
20	2.4	3.8	-	-	-
23	2.1	3.3	-	-	-
30	1.7	2.6	3.7	-	-
33	1.5	2.3	3.4	-	-
50	1.0	1.6	2.2	5.0	-
60	-	1.3	1.9	4.2	-
80	-	1.0	1.4	3.1	5.6
100	-	0.8	1.1	2.5	4.5
120	-	0.7	0.9	2.1	3.7
150	-	0.5	0.5	1.7	2.3

### 1.3.8.5 VERTICAL CURVES

[www.binils.com](http://www.binils.com)

Vertical curves are introduced for smooth transition at grade changes. The vertical curves may be classified into two categories. 1. Summit curves or crest curves with convexity upwards. 2. Valley or sag curves with concavity upwards.

Both summit curves and valley curves should be designed as parabola, the length of the vertical curves is controlled by sight distance requirements, but curves with greater lengths are aesthetically better. Curves should be provided at all grade changes exceeding those given in below.

**Table : 1.3.8.5 Minimum length of Vertical curve (IRC SP : 20 - 2002, Page No. 42)**

Design speed	Maximum grade change (%) not requiring a vertical	Minimum length of vertical curve in (m)
Upto 35	1.5	15
40	1.2	20
50	1.0	30

### 1.3.8.6 SUMMIT CURVE

The length of summit curve is governed by the choice of sight distance according to the operating condition of road. The required length may be calculated from the formulae given in Table.

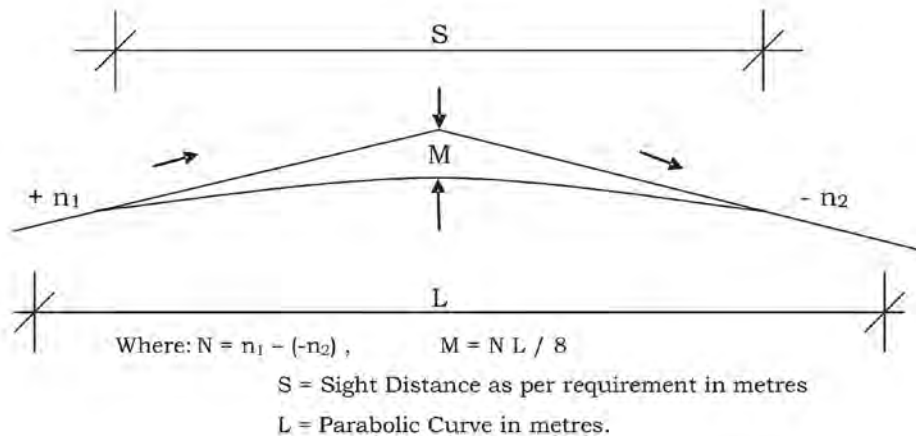

### 1.3.8.6 Summit Curve

Table: 1.3.8.6 Length of summit curve (IRC SP : 23 - 1993)

Case	For stopping sight distance	For intermediate sight distance / overtaking sight
$L > S$	$L = NS^2/4.4$	$L = NS^2/9.6$
$L < S$	$L = 2S - (4.4)/N$	$L = 2S - (9.6)/N$

Where

$N$  = deviation angle, i.e. the algebraic difference between the two grades.

$L$  = Length of parabolic vertical curve in metres.

$S$  = Sight Distance in metres.

Note : 1. For summit curves, overtaking sight distance should be the general criterion. Where it is not feasible, intermediate sight distance should be adopted as the next best. Safe stopping sight distance is the absolute minimum.

2. For valley curves, safe stopping sight distance should be adopted.



**1.3.8.7 VALLEY CURVE :**

The length of valley transition curve is designed based on the two criteria

- The allowable rate of change of centrifugal acceleration of 0.6 m/sec<sup>3</sup> and
- The head light sight distance, and the higher of the two values may be adopted.

Usually the second criterion of head light sight distance is higher and therefore governs the design.

- (a) The length of valley transition curve according to first criteria i.e. for comfort condition is given by

$$L = 0.38 (NV^3)^{1/2}$$

- (b) The length of valley curve according to the second criteria may be calculated by using the formulae given in below.

**Table: 1.3.8.7.1 Length of Valley Curve (IRC SP : 23 - 1993, Page No. 21)**

Case	Length of valley curve
$L > S$	$L = NS^2 / (1.5 + 0.035 S)$
$L < S$	$L = 2S - (1.5 + 0.035 S) / N$

[www.binils.com](http://www.binils.com)

Where

N = deviation angle, i.e. the algebraic difference between the two grades

L = Length of parabolic vertical curve in metres

S = sight distance requirements in metres.

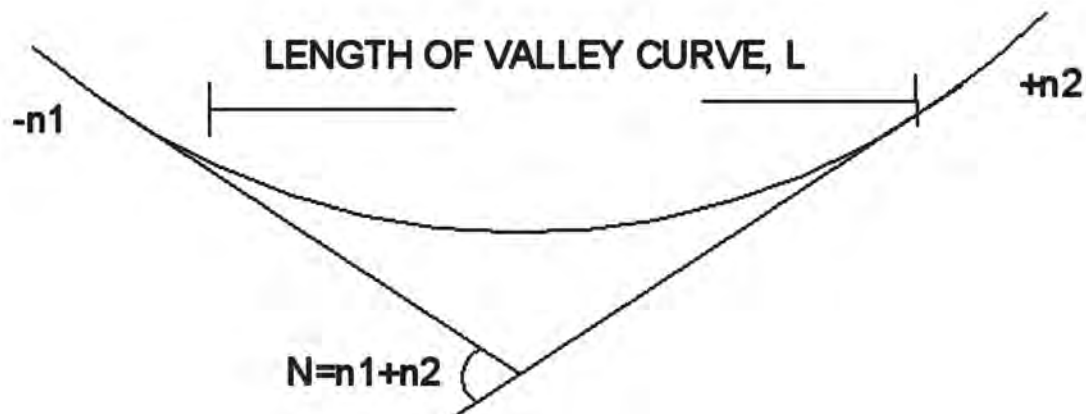

**1.3.8.7.2 Length of Valley Curve**

## **1.4 TRAFFIC ENGINEERING**

### **1.4.1 OBJECTIVES OF TRAFFIC ENGINEERING:**

The main objectives of traffic engineering are listed below

- ✓ To have a safe, convenient, rapid and economic transport of persons and goods.
- ✓ To achieve smooth and easy flow of traffic at intersections
- ✓ To improve the riding comfort and speed of vehicles
- ✓ To make the roads safe for the movement of pedestrians and vehicles
- ✓ To remove traffic congestion and reduce delay in road journeys.
- ✓ To provide vital data about the condition of existing traffic for improvement for future requirements.

### **1.4.2 TRAFFIC SURVEY:**

The types of traffic surveys are usually carried out are grouped as follows

- 1) Origin and destination Survey
- 2) Traffic Volume Survey
- 3) Spot Speed survey
- 4) Accident Survey
- 5) Speed and delay survey
- 6) Parking Survey

#### **1.4.2.1 PURPOSE OF TRAFFIC STUDIES:**

The main purpose of traffic studies are

- ✓ To determine the facilities to be provided on road and suggest the measures to improve the traffic of the road
- ✓ To get suitable data for geometric design of various components of road
- ✓ To get information related to nature of traffic at present and to forecast its future trend
- ✓ To analyze the road accidents and to find out road elements contributing to their occurrence
- ✓ To initiate appropriate action to eliminate the condition contributing the accidents.
- ✓ To suggest measures to control speed of vehicles

### **1.4.3 ROAD ACCIDENTS:**

Road accidents are undoubtedly the most serious eventuality due to defective traffic planning and controlling the traffic. Road accidents result in vital loss of human life and consequent

economic depreciation of a country especially the victim is a knowledgeable and skilled person. The reasons for this are the extremely dense chaotic road traffic and the relatively great freedom of movement given to drivers. Accidents involving heavy goods vehicles (especially coaches and lorries with trailers) occur all too frequently despite calls for responsible behaviour and respect for rules and regulation pertaining to the traffic., It is also due to irresponsible behaviour of drivers such as drunken driving and non-adherence of speed restriction at different zones and non adaptability of driving in adverse weather conditions (like rain, ice, fog, etc.). The prevention of road accidents is also extremely important and will be ensured by strict laws, by technical and police controls, ongoing training for drivers (especially those involved in the transport of dangerous and hazardous substances) and strict legal punishment to the erring drivers.

#### **1.4.4 CAUSES OF ROAD ACCIDENTS:**

- Non-licensed and inexperienced drivers.
- Driving by minors.
- Driving at high speed during night- time.
- Driving during cold waves, mist, fog, dust storms, and cyclonic storms.
- Driving in a state of drunkenness or under the influence of sedating drugs.
- Eagerness to fulfill work schedules.
- Defective and old vehicles.
- Poor maintenance of vehicles.
- Night blindness of drivers.
- Passing through narrow and congested roads in high speed.
- Driving when red light is on and ignoring traffic signs.
- Driving without lights during heavy downpours.
- Poor or no street lighting.
- Inattentive pedestrians walking at the center of the road.
- Cyclists and cycle rickshaws without headlights during the night.
- Sudden appearance of stray cattle and side traffic. Accident victims are generally left unattended on the road especially pedestrians and cyclists till police arrive.
- Fraudulent means are used in getting driving licenses from the transport department. Such improper issue of driving licenses is responsible for causing accidents due to human error.

- Drunken driving during the night is a major reason for accidents as drivers lose control.
- Lack of adequate road signs and information increases accidents on roads.
- Overtaking the moving vehicle without assessing the traffic condition ahead of the road.

#### **1.4.5 PREVENTIVE MEASURES:**

1. The condition which leads to accident mentioned in the above paragraph (1.4.4) should be removed to have a safe transport on the highways.
2. Obey traffic rules and initiate severe penal action on erring driver
3. Insist wearing of seat belts of driver and other passengers in the vehicle.
4. Preference is to be given to pedestrians and children crossing the road especially on zebra crossing.
5. Erect road signs at appropriate places in predominant manner
6. It is vital to install reflectors on roads so that deviations and medians are clearly visible to drivers.
7. Establishment of road safety departments by governments to build capacity at national and local levels to monitor the magnitude, severity and burden of road traffic collisions and injuries.
8. Setting up of safety standards for motor vehicles in consonance with international practice.
9. Designing roads and highways with special attention to the needs of vulnerable road users and promotion of traffic calming techniques.
10. Marking separate lanes for bicyclists

#### **1.4.6 PARKING**

Parking is one of the major problems that are created due to the increased vehicular road traffic. The availability of less space in urban areas has increased the demand for parking space, especially in areas like Central business district. The lack of adequate parking space for vehicle affects the economic activities adversely in urban areas.

#### **1.4.7 METHODS OF PARKING**

##### **1.4.7.1 ON STREET PARKING**

On street parking means the vehicles are parked on the sides of the street itself. This will be usually controlled by government agencies itself. Common types of on-street parking are as listed below. This classification is based on the angle in which the vehicles are parked

with respect to the road alignment. As per IRC, the standard dimensions of a car is taken as  $5 \times 2.5$  metres and that for a truck is  $3.75 \times 7.5$  metres.

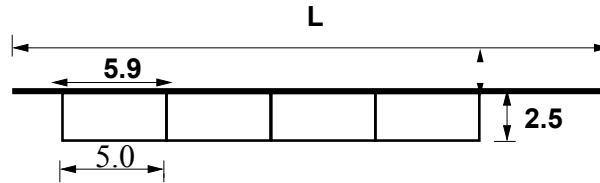

1.4.7.1 (a) Illustration of parallel parking

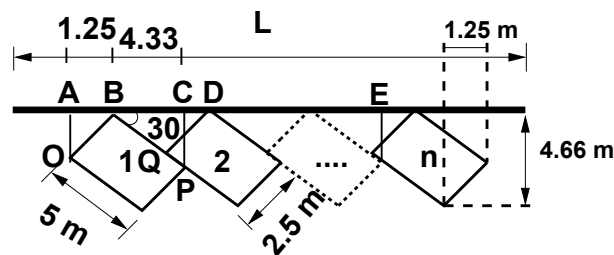

1.4.7.1 (b) Illustration of  $30^\circ$  parking

[www.binils.com](http://www.binils.com)

- i. **Parallel parking:** The vehicles are parked along the length of the road. Here there is no backward movement involved while parking or taking out the vehicle. Hence, it is the safest parking from the accident perspective. However, it consumes the maximum curb length and therefore only a minimum number of vehicles can be parked for a given kerb length. This method of parking produces least obstruction to the on-going traffic on the road since least road width is used. Parking and taking out the car from the parking is difficult in this Parallel parking.
- ii.  **$30^\circ$  parking:** In thirty degree parking, the vehicles are parked at  $30^\circ$  with respect to the road alignment. In this case, more vehicles can be parked compared to parallel parking. Also there is better maneuverability. Delay caused to the traffic is also less in this type of parking.

- iii. **45° parking:** As the angle of parking increases, more number of vehicles can be parked. Hence compared to parallel parking and thirty degree parking, more number of vehicles can be accommodated in this type of parking.

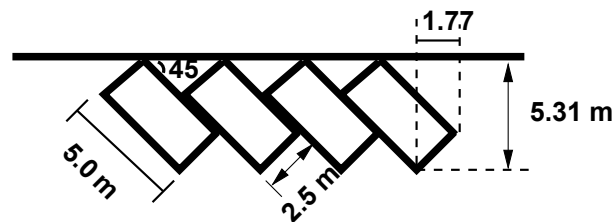

1.4.7.1 (c) 45 Degree Parking

- iv. **60° parking:** The vehicles are parked at 60° to the direction of road. More number of vehicles can be accommodated in this parking type.

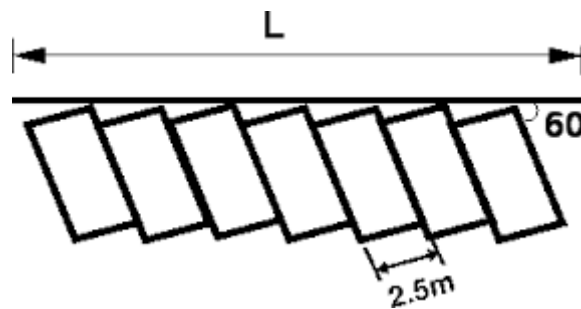

1.4.7.1 (d) 60 Degree Parking

- v. **Right angle parking:** In right angle parking or 90° parking, the vehicles are parked perpendicular to the direction of the road. Although it consumes more width of the road, but kerb length required is very little. In this type of parking, the vehicles need complex maneuvering and this may cause severe accidents. This arrangement causes obstruction to the road traffic particularly if the road width is

less. However, it can accommodate maximum number of vehicles for a given kerb length.

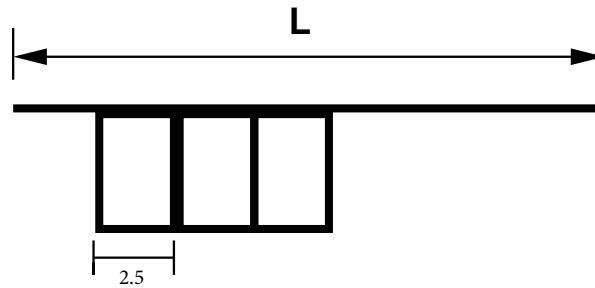

1.4.7.1 (e) **Illustration of 90° parking**

### 1.4.7.2 OFF STREET PARKING

In many urban centres, some areas are exclusively allotted for parking which will be at some distance away from the main stream of traffic. Such a parking is referred to as off-street parking. They may be operated by either public agencies or private firms. A typical layout of an off-street parking is shown in figure.

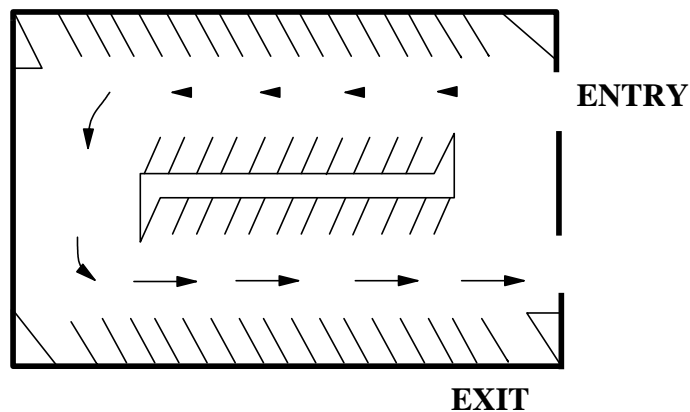

1.4.7.2. **Illustration of off-street parking**

### 1.4.7.3. MULTIPLE LEVEL CAR PARKING

It is a building (or part there hereof) which is designed specifically to be for Automobile Parking and where there are a number of floors or levels on which parking takes place.

In order to accommodate the large volume of vehicles, small cities and towns must develop their infrastructure. One solution may be a multi-level car parking system to maximize car parking capacity by utilizing vertical space, rather than expand horizontally. With land in metros and 'A' grade cities becoming scarce and dearer, and plots getting smaller, conventional parking is proving infeasible.

### 1.4.8 ROAD JUNCTION

#### 1.4.8.1 TRAFFIC INTERSECTIONS

Intersection is an area shared by two or more roads. This area is designated for the vehicles to turn to different directions to reach their desired destinations. Its main function is to guide vehicles to their respective directions. Traffic intersections are complex locations on any highway. This is because vehicles moving in different direction want to occupy same space at the same time. In addition, the pedestrians also seek same space for crossing. Drivers have to make split second decision at an intersection by considering his route, intersection geometry, speed and direction of other vehicles etc. A small error in judgment can cause severe accidents. It also causes delay and it depends on type, geometry, and type of control. Overall traffic flow is controlled by road signal. It also affects the capacity of the road. Therefore, both from the accident perspective and the capacity perspective, the study of intersections is very important for the traffic engineers especially in the case of urban scenario.

The intersections are of two types. They are at-grade intersections and grade-separated intersections.

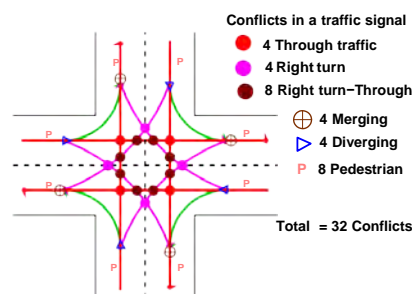

1.4.8.1 Conflicts at an intersection



**i. AT-GRADE INTERSECTIONS:**

In at-grade intersections, all roadways join or cross at the same vertical level. The essence of the intersection control is to resolve these conflicts at the intersection for the safe and efficient movement of both vehicular traffic and pedestrians. Two methods of intersection controls are there: time sharing and space sharing. The type of intersection control that has to be adopted depends on the traffic volume, road geometry, cost involved, importance of the road etc. The above sketch explains the negotiations of traffic moving in the different direction at an intersection.

**ii. CHANNELIZED INTERSECTION:**

Vehicles approaching an at At-grade intersection are directed to definite paths by islands, marking etc. and this method of control is called channelization. Channelized intersection provides more safety and efficiency. It reduces the number of possible conflicts by reducing the area of conflicts available in the carriageway. Channelization of traffic through a three-legged intersection and a four-legged intersection is shown in the figure 1.4.8.1 (a) and 1.4.8.1 (b) .

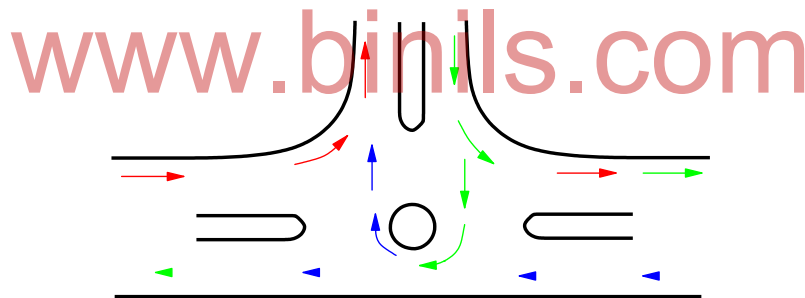

1.4.8.1 (a) Channelization of traffic through a three-legged intersection

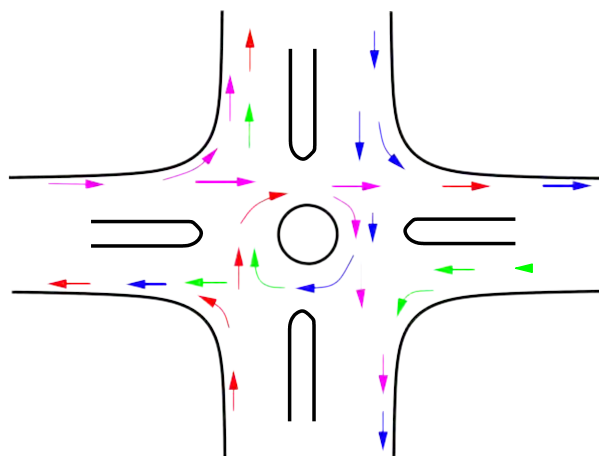

1.4.8.1 (b) Channelization of traffic through a four-legged intersection

### 1.4.8.2 GRADE SEPARATED INTERSECTION:

Grade separated intersections allows the traffic to cross at different vertical levels. Sometimes the topography itself may be helpful in constructing such intersections. Otherwise, the initial construction cost required will be very high. Therefore, they are usually constructed on high speed facilities like expressways, freeways etc. This type of intersection increases the road capacity because vehicles can flow with high speed and accident potential is also reduced due to vertical separation of traffic.

Grade-separated intersections are provided to separate the traffic in the vertical grade. But the traffic need not be those pertaining to road only. When a railway line crosses a road, then also grade separators are used. Different types of grade-separators are flyovers and interchange. Flyovers itself are subdivided into overpass and underpass. When two roads cross at a point, if the road having major traffic is elevated to a higher grade for further movement of traffic, then such structures are called overpass. Otherwise, if the major road is depressed to a lower level to cross another by means of an under bridge or tunnel, it is called under-pass.

- i. **INTERCHANGE:** Interchange is a system where traffic between two or more roadways flows at different levels in the grade separated junctions. Common types of interchange include trumpet interchange, diamond interchange, and cloverleaf interchange.
- ii. **TRUMPET INTERCHANGE:** Trumpet interchange is a popular form of three leg interchange. If one of the legs of the interchange meets a highway at some angle but does not cross it, then the interchange is called trumpet interchange. A typical layout of trumpet interchange is shown in figure.

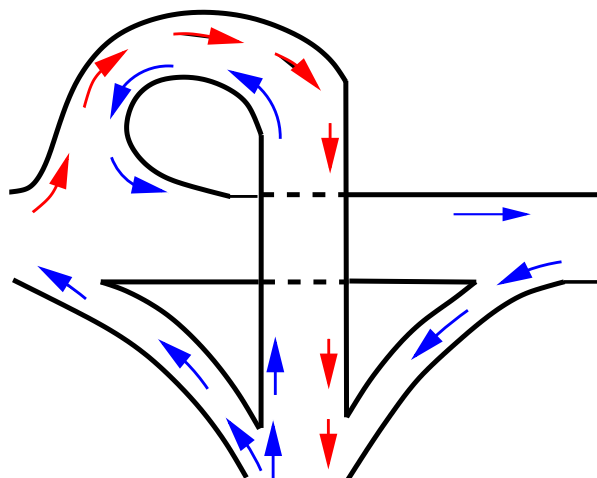

1.4.8.2. (a) Trumpet Interchange

**iii. Diamond interchange:** Diamond interchange is a popular form of four-leg interchange found in the urban locations where major and minor roads crosses. The important feature of this interchange is that it can be designed even if the major road is relatively narrow. A typical layout of diamond interchange is shown in figure.

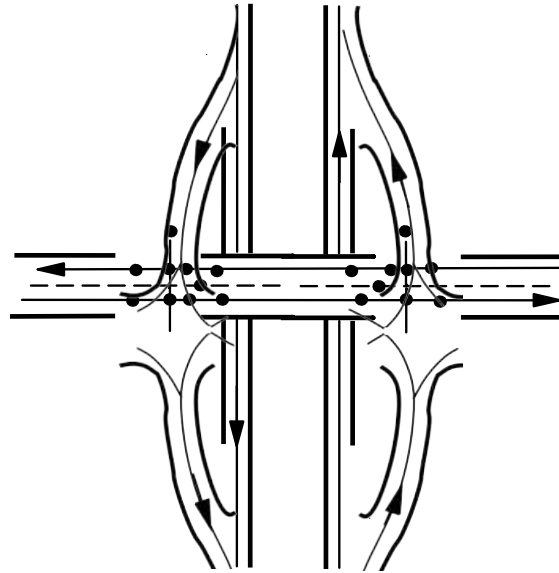

1.4.8.2 (iii) Diamond interchange

**iv. Clover leaf interchange:** It is also a four leg interchange and is used when two highways of high volume and speed intersect each other with considerable turning movements. The main advantage of cloverleaf intersection is that it provides complete separation of traffic. In addition, high speed at intersections can be achieved. However, the disadvantage is that large area of land is required. Therefore, cloverleaf interchanges are provided mainly in rural areas. A typical layout of this type of interchange is shown in figure.

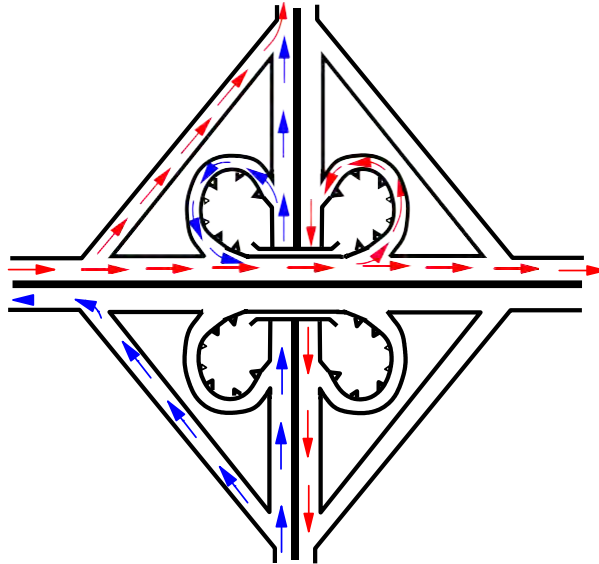

1.4.8.2. (iv) Cloverleaf interchange

## 1.4.9 TRAFFIC SIGNALS:

### 1.4.9.1. REQUIREMENTS OF TRAFFIC CONTROL DEVICES

The control device should fulfill a need: Each device must have a specific purpose for the safe and efficient operation of traffic flow. The superfluous devices should not be used.

It should command attention from the road users: This affects the design of signs. For commanding attention, proper visibility should be there. Also the sign should be distinctive and clear. The sign should be placed in such a way that the driver requires no extra effort to see the sign.

It should convey a clear, simple meaning: Clarity and simplicity of message is essential for the driver to properly understand the meaning in short time. The use of color, shape and legend as codes becomes important in this regard. The legend should be kept short and simple so that even a less educated driver could understand the message in less time.

The control device should provide adequate time for proper response from the road users: This is again related to the design aspect of traffic control devices. The sign boards should be placed at a distance such that the driver could see it and gets sufficient time to respond to the situation. For example, the STOP sign which is always placed at the stop line of the intersection should be visible for at least one safe stopping sight distance away from the stop line.

### 1.4.10 TYPES OF TRAFFIC SIGNS

Traffic signs are means for exercising control on or passing information to the road users. Among the design aspects of the signs, the size, shape, color and location matters.

There are several hundreds of traffic signs available covering wide varieties of traffic situations. They can be classified into three main categories. They may be regulatory, warning, or informative.

**1.4.10.1 REGULATORY SIGNS:** These signs require the driver to obey the signs for the safety of other road users.

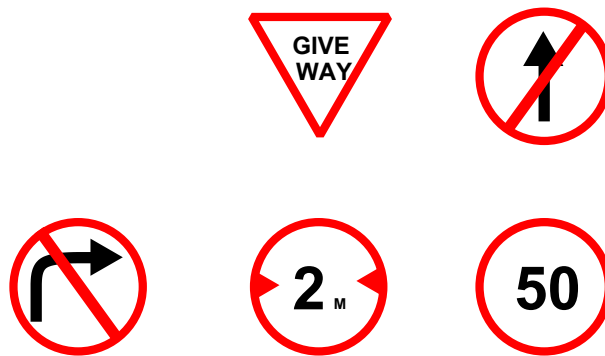

Examples of regulatory signs ( give way sign, signs for no entry, sign indicating prohibition for right turn, vehicle width limit sign, speed limit sign)

**1.4.10.2. WARNING SIGNS:** These signs are for the safety of oneself who is driving and advice the drivers to obey these signs. Examples of cautionary signs ( right hand curve sign board, signs for narrow road, sign indicating railway track ahead)

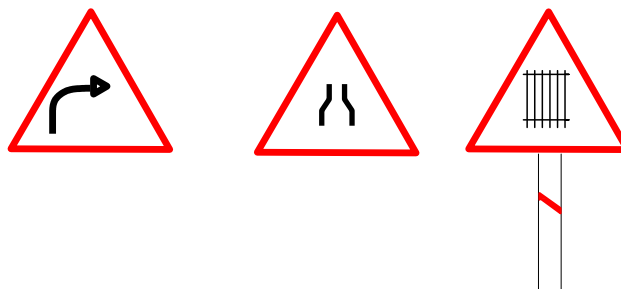

Warning signs or cautionary signs give information to the driver about the impending road condition. They advice the driver to obey the rules. These signs are meant for the own safety of drivers. They call for extra vigilance from the part of drivers. The color convention used for this type of signs is that the legend will be black

**1.4.10.3 INFORMATIVE SIGNS:** These signs provide information to the driver about the facilities available ahead, and the route and distance to reach the specific destinations

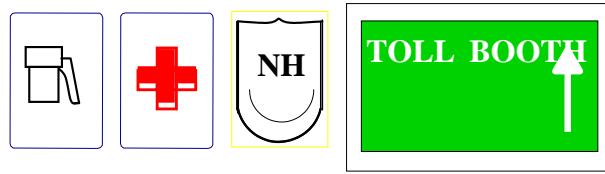

Examples of informative signs (route markers, destination signs, mile posts, service centre information etc)

#### 1.4.11 EXPRESSWAYS

Expressways are the highest class of roads in the Indian road network. They are six or eight-lane controlled-access highways where entrance and exit is controlled by the use of slip roads. Expressways connect many cities and town on its way to its destination. The distance covered by an expressway is very large compared to other type highways. The speed limit allowed in the expressway is of high order and hence a very large distance can be in short period time. Currently, India has approximately 1,324 km of expressways. The National Highways Development project by Government of India aims to expand the highway network and plans to add an additional 18,637 km of expressways by the year 2022. National Expressways Authority of India operating under the Ministry of Road Transport and Highways will be in-charge of the construction and maintenance of expressways.

Agra-Lucknow Expressway will become the longest expressway in India replacing Yamuna Expressway.



1.4.11 (a) Mumbai-Pune Expressway



1.4.11 (b) Durgapur Expressway in West Bengal, part of NH 2



1.4.11 (c) Himalayan Expressway, Haryana

## **1.5 SUB GRADE SOIL**

### **1.5.1 SIGNIFICANCE**

All civil engineering structures including road pavement are founded on soils. The soil provides a good foundation for bearing the load coming from the pavement. Therefore, a good knowledge of soil and its behavior under different moisture condition, degree of compaction, consolidation is a must for designing a good pavement.

The main constituents of a pavement structure comprise of soils, mineral aggregates, bituminous binders and stabilizers like lime, cement etc. Among these, mineral aggregates play the major role. All roads have to be formed on soil and are required to make optimum use of the locally available materials, if it is to be economical. The materials, which are of concern in the structural layers of the pavement, should be selected based on suitability, availability, economy and previous experience. This aspect must be considered at the design stage so that the materials which are the most economical and best suited to the prevailing conditions can be selected.

### **1.5.2 PHASE RELATIONSHIP OF SOILS:**

Soil is not a coherent solid material like steel and concrete, but is a particulate material. Soils, as they exist in nature, consist of solid particles (mineral grains, rock fragments) with water and air in the voids between the particles. The water and air contents are readily changed by changes in ambient conditions and location.

As the relative proportions of the three phases (Soil particle, Water, Air voids) vary in any soil deposit, it is useful to consider a soil model which will represent these phases distinctly and properly quantify the amount of each phase. A schematic diagram of the three-phase system is shown in terms of weight and volume symbols respectively for soil solids, water, and air. The weight of air can be neglected.



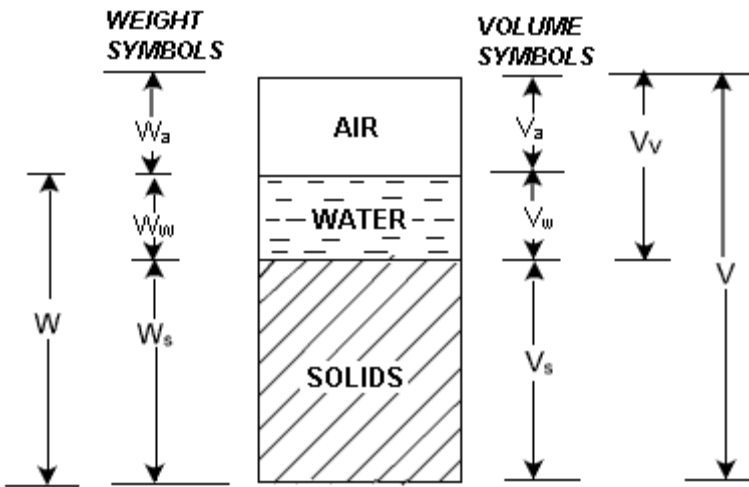

### 1.5.2 (a) Phase Relationship

The soil model is given dimensional values for the solid, water and air components.

Total volume,  $V = V_s + V_w + V_v$

Soils can be partially saturated (with both air and water present), or be fully saturated (no air content) or be perfectly dry (no water content).

[www.binils.com](http://www.binils.com)

In a saturated soil or a dry soil, the three-phase system thus reduces to two phases only, as shown.

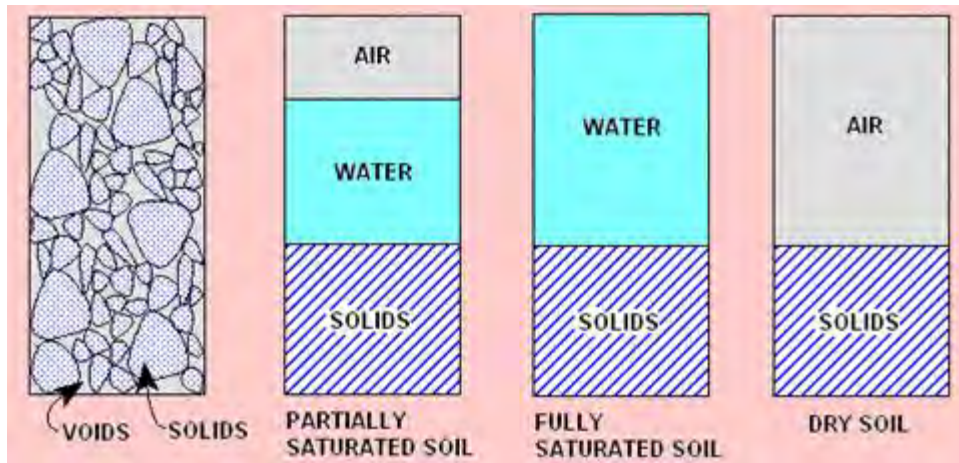

### 1.5.3 (b) Soil 3 Phase System

For the purpose of engineering analysis and design, it is necessary to express relations between the weights and the volumes of the three phases.

### 1.5.2.1 VOLUME RELATIONS

As the amounts of both water and air are variable, the volume of solids is taken as the reference quantity. Thus, several relational volumetric quantities may be defined. The following are the basic volume relations:

1. Void ratio ( $e$ ) is the ratio of the volume of voids ( $V_v$ ) to the volume of soil solids ( $V_s$ ), and is expressed as a decimal.

$$e = \frac{V_v}{V_s}$$

2. Porosity ( $n$ ) is the ratio of the volume of voids to the total volume of soil ( $V$ ), and is expressed as

a percentage. 
$$n = \frac{V_v}{V} \times 100$$

Void ratio and porosity are inter-related to each other as follows:

$$e = \frac{n}{1-n} \quad \text{and} \quad n = \frac{e}{(1+e)}$$

3. The volume of water ( $V_w$ ) in a soil can vary between zero (i.e. a dry soil) and the volume of voids. This can be expressed as the degree of saturation ( $S$ ) in percentage.

$$S = \frac{V_w}{V_v} \times 100$$

For a dry soil,  $S = 0\%$ , and for a fully saturated soil,  $S = 100\%$ .

4. Air content ( $\alpha_c$ ) is the ratio of the volume of air ( $V_a$ ) to the volume of voids.

$$\alpha_c = \frac{V_a}{V_v}$$

5. Percentage air voids ( $n_a$ ) is the ratio of the volume of air to the total volume.

$$n_a = \frac{V_a}{V} \times 100 = n \times \alpha_c$$

### 1.5.2.2. WEIGHT RELATIONS

Density is a measure of the quantity of mass in a unit volume of material. Unit weight is a measure of the weight of a unit volume of material. Both can be used interchangeably. The units of density are ton/m<sup>3</sup>, kg/m<sup>3</sup> or g/cm<sup>3</sup>. The following are the basic weight relations:

1. The ratio of the mass of water present to the mass of solid particles is called the water content (w), or sometimes the moisture content.

$$w = \frac{W_w}{W_s}$$

Its value is 0% for dry soil and its magnitude can exceed 100%.

2. The mass of solid particles is usually expressed in terms of their particle unit weight ( $\gamma_s$ ) or specific gravity ( $G_s$ ) of the soil grain solids .

$$\gamma_s = \frac{W_s}{V_s} = G_s \cdot \gamma_w$$

where  $\gamma_w$  = Unit weight of water

For most inorganic soils, the value of  $G_s$  lies between 2.60 and 2.80. The presence of organic material reduces the value of  $G_s$ .

3. Dry unit weight ( $\gamma_d$ ) is a measure of the amount of solid particles per unit volume.

$$\gamma_d = \frac{W_s}{V}$$

4. Bulk unit weight ( $\gamma_t$  or  $\gamma$ ): is a measure of the amount of solid particles plus water per unit volume.

$$\gamma_t = \gamma = \frac{(W_s + W_w)}{(V_s + V_v)}$$

5. Saturated unit weight ( $\gamma_{sat}$ ) is equal to the bulk density when the total voids is filled up with water.

6. Buoyant unit weight ( $\gamma'$ ) or submerged unit weight is the effective mass per unit volume when the soil is submerged below standing water or below the ground water table.

$$\gamma' = \gamma_{sat} - \gamma_w$$

### 1.5.3. SOIL GRAIN SIZE CLASSIFICATION

All soils, as per the **Indian Soil Classification System**, are divided into three main groups:

- Coarse-grained soils, having more than half the total material by weight, larger than 75 micron sieve size.
- Fine-grained soils, having more than half the total material by weight smaller than 75 micron sieve size.
- Highly organic soils: these soils contain larger percentages of fibrous organic matter such as peat and particles of decomposed vegetation. In addition, certain soils containing shells, concretions, cinders and other non- soil materials in sufficient quantities are also included in this group.

[www.binils.com](http://www.binils.com)

Based on particle size, the soils can be classified as under, adopting the IS soil classification system:

The broad classification of soils (as per IS) into Gravels, Sands, Silts and Clays based on particle size is as under:

CLAY	SILT	SAND			GRAVEL
		Fine Sand	Medium Sand	Coarse Sand	
0.002mm (2 micron)	0.075mm (75 micron)	0.425mm (425 micron)	2.0 mm	4.75 mm	

#### 1.5.4 ATTERBERG LIMITS:

1. **Liquid Limit (LL)** is the minimum water content ( $w_l$ ) at which the soil can flow under its own weight (has no strength). It is defined as the moisture content at which 25 blows (taps) in the standardized liquid limit determination device (Casagrande apparatus), will just close a specific groove in a sample of soil. Another common method for its determination is the cone penetrometer test method.

2. **Plastic Limit (PL)** is the minimum water content ( $w_p$ ) at which the soil can be rolled into a thread 3 mm in diameter, without breaking.

3. **Shrinkage Limit (SL)** is the water content at which further loss of moisture does not cause a decrease in the volume of the soil.

4. **Plasticity Index (PI or  $I_p$ )** is defined as the water content range over which a soil exhibits plastic behavior. It is the difference between the Liquid and Plastic Limits of a soil.  $PI = LL - PL$ ;  $I_p = w_l - w_p$ .

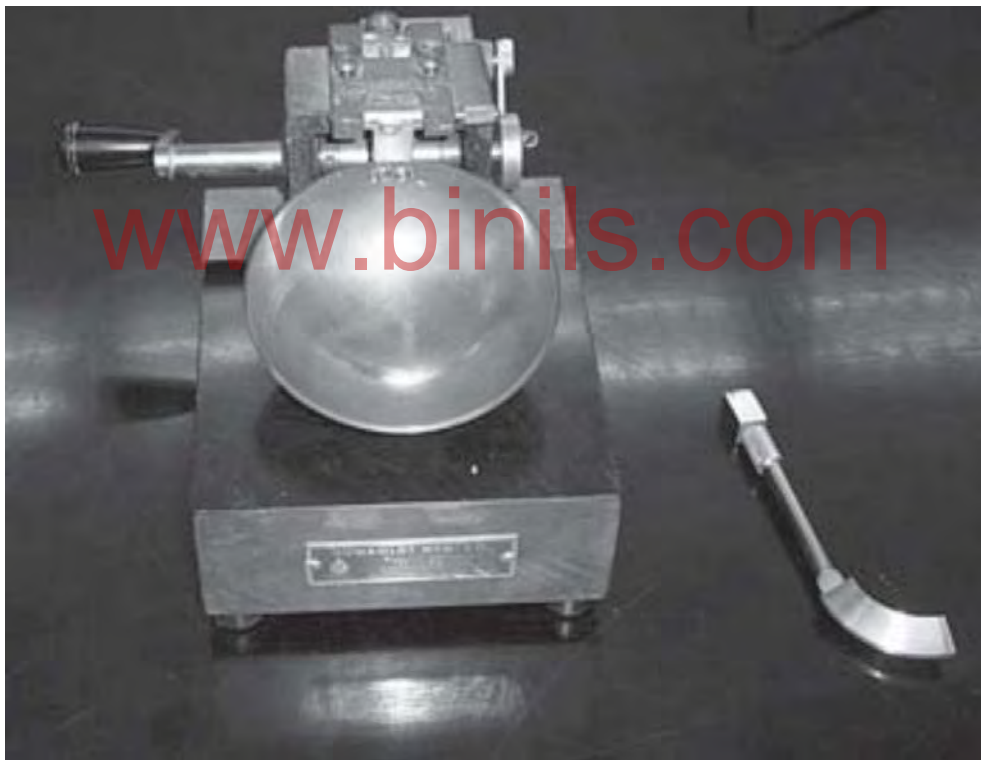

Fig: 1.5.4.1 Casagrande Liquid Limit Apparatus

Atterberg limits are very useful to identify the soil we come across in the field. Each and every soil has a set of Atterberg limit values; and these values are related to the behavioral aspects of soil considered.

### 1.5.5 COMPACTION OF SOILS:

Compaction is the process of applying the mechanical energy (Tamping rod) to a soil so as to rearrange its particles and reduce the void ratio. Compaction is applied to improve the properties of an existing soil. In road formation the soil is compacted densely to form the road base to support the other components of the pavement. Compaction is also used to prepare a level surface during construction of buildings, runway formation etc., There is usually no change in the water content and in the size of the individual soil particles.

The objectives of compaction are:

- ✓ To increase soil shear strength and therefore its bearing capacity.
- ✓ To reduce subsequent settlement under working loads.
- ✓ To reduce soil permeability making it more difficult for water to flow through because of dense packing of particles.

### 1.5.6. STANDARD PROCTOR COMPACTION TEST

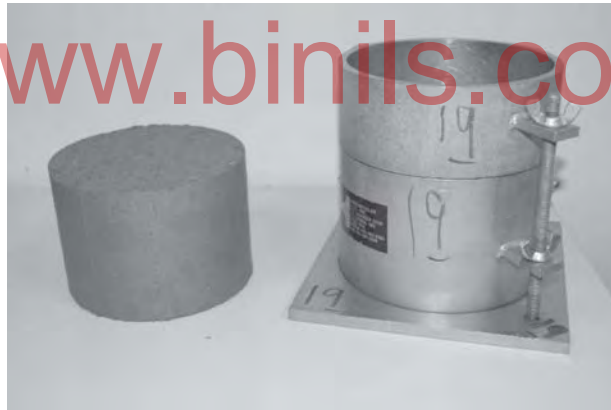

Fig: 1.5.6 Standard Proctor Compaction Test Apparatus

The Standard Proctor compaction test is carried out to determine the relationship between the moisture content and density of soils compacted in a mould of a given size with a 2.5 kg rammer dropped from a height of 30 cm. the results obtained from this test will be helpful in increasing the bearing capacity of foundations, Decreasing the undesirable settlement of structures, Control undesirable volume changes, Reduction in hydraulic conductivity, Increasing the stability of slopes and so on.

## APPARATUS REQUIRED:

- Proctor mould having a capacity of 944 cc with an internal diameter of 10.2 cm and a height of 11.6 cm. The mould shall have a detachable collar assembly and a detachable base plate.
- Rammer: A mechanical operated metal rammer having a 5.08 cm diameter face and a weight of 2.5 kg. The rammer shall be equipped with a suitable arrangement to control the height of drop to a free fall of 30 cm.
- Sample extruder, mixing tools such as mixing pan, spoon, towel, and spatula.
- A balance of 15 kg capacity, Sensitive balance, Straight edge, Graduated cylinder, Moisture tins.

## PROCEDURE:

- Take a representative oven-dried sample, approximately 5 kg in the given pan. Thoroughly mix the sample with a certain quantity of water. (approximately water content of 4-6 %).
- Weigh the proctor mould without base plate and collar. Fix the collar and base plate. Place the soil in the Proctor mould and compact it in 3 layers giving 25 blows per layer with the 2.5 kg rammer falling through. The blows shall be distributed uniformly over the surface of each layer.
- Remove the collar; trim the compacted soil even with the top of mould using a straight edge and weigh.
- Divide the weight of the compacted specimen by 944 cc and record the result as the bulk density bulk.
- Remove the sample from mould and slice vertically through and obtain a small sample for water content.
- Thoroughly break up the remainder of the material until it will pass a no.4 sieve as judged by the eye. Add water in sufficient amounts to increase the moisture content of the soil sample by one or two percentage points and repeat the above procedure for each increment of water added. Continue this series of determination until there is either a decrease or no change in the wet unit weight of the compacted soil.

Plot dry density vs. moisture content as shown in the following sketch and find out the max dry density and optimum moisture for the soil.

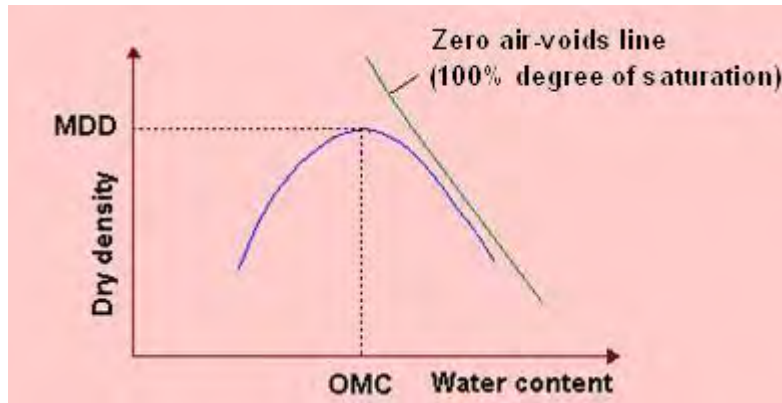

### 1.5.6 OMC vs Dry Density

The above two values namely, maximum dry density and optimum moisture content assumes significant in the compaction of the soil for forming soil base.

### 1.5.7 SHEAR STRENGTH OF SOILS:

Soils consist of individual particles that can slide and roll relative to one another. Shear strength of a soil is equal to the maximum value of shear stress that can be mobilized within a soil mass without failure taking place.

The shear strength of a soil is a function of the stresses applied to it as well as the manner in which these stresses are applied. Knowledge of shear strength of soils is necessary to determine the bearing capacity of foundations, the lateral pressure exerted on retaining walls, and the stability of slopes.

### 1.5.8 DIRECT SHEAR TEST

The test is carried out on a soil sample confined in a metal box of square cross-section which is split horizontally at mid-height. A small clearance is maintained between the two halves of the box. The soil is sheared along a predetermined plane by moving the top half of the box relative to the bottom half. The box is usually square in plan of size 60 mm x 60 mm. A typical shear box is shown.

#### **Objective**

Determination of shear strength parameters of a silty or sandy soil at known density and moisture content.

#### **Apparatus**

Shear box with clamping screws, Box container, Porous stones, Grid plates (serrated and perforated), Tamper, Balance, Loading frame, Proving ring, Deformation dial gauges, Apparatus for moisture content determination.



## Procedure

1. Measure shear box dimensions, set up the box by fixing its upper part to the lower part with clamping screws, and then place a porous stone at the base.
2. For undrained tests, place a serrated grid plate on the porous stone with the serrations at right angle to the direction of shear. For drained tests, use a perforated grid over the porous stone.
3. Weigh an initial amount of soil in a pan. Place the soil into the shear box in three layers and for each layer apply a controlled amount of tamping with a tamper. Place the upper grid plate, porous stone and loading pad in sequence on the soil specimen. Weigh the pan again and compute the mass of soil used.
4. Place the box inside its container and mount it on the loading frame. Bring the upper half of the box in contact with the horizontal proving ring assembly. Fill the container with water if soil is to be saturated.
5. Complete the assembly, removes the clamping screws from the box, and initializes the horizontal displacement gauge, vertical displacement gauge and proving ring gauge to zero.
6. Set the vertical normal stress to a predetermined value. For drained tests, allow the soil to consolidate fully under this normal load. Avoid this step for undrained tests.
7. Start the motor with a selected speed and apply shear load at a constant rate of strain. Continue taking readings of the gauges until the horizontal shear load peaks and then falls, or the horizontal displacement reaches 20% of the specimen length.
8. Determine the moisture content of the specimen after the test. Repeat the test on identical specimens under different normal stress values.

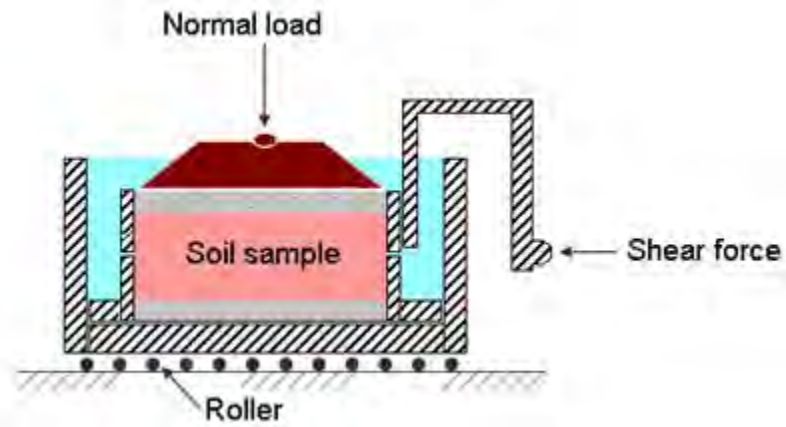

1.5.8. Direct Shear Apparatus

If the soil sample is fully or partially saturated, perforated metal plates and porous stones are placed below and above the sample to allow free drainage. If the sample is dry, solid metal plates are used. A load normal to the plane of shearing can be applied to the soil sample through the lid of the box.

Tests on sands and gravels can be performed quickly, and are usually performed dry as it is found that water does not significantly affect the drained strength.

As a vertical normal load is applied to the sample, shear stress is gradually applied horizontally, by causing the two halves of the box to move relative to each other. The shear load is measured together with the corresponding shear displacement. The change of thickness of the sample is also measured.

A number of samples of the soil are tested each under different vertical loads and the value of shear stress at failure is plotted against the normal stress for each test, provided there is no excess pore water pressure in the soil, the total and effective stresses will be identical. From the stresses at failure, the failure envelope can be obtained.

## 1.6 ROAD ARBORICULTURE AND LIGHTING

Tree planting or arboriculture is the most important component of highway landscaping. Planting may be functional, or for aesthetic effects, but in either case the objective should be to help restore the unity of the landscape. Functional planting applies to such problems as protection of slopes against erosion, screening of unsightly views, reducing headlight glare, providing shade in summer and so on. In most cases, such planting also improves the appearance of the road and enhances the natural landscape, planting for aesthetic effects is also by and large functional but goes beyond that to blend the road into the surrounding countryside and enhance the overall beauty. The trees on both side of road break the monotony of the driving and act as sound barrier.

Roadside planting of trees may be in the form of avenues, groups or groves. Where conditions are favourable, for example in groves, fruit bearing trees may be preferred.

In the design and development of arboriculture, certain restrictions imposed by engineering, traffic and safety requirements should be kept in view.

Some of these are:

- a) Position of trees on either side should be fixed taking into account the ultimate development of the roadway with regard to future widening.
- b) Trees should be planted beyond 1 m back from the ultimate edge of the roadway so that they are not a safety hazard or affect the required sight distances.
- c) Considerations of sight distance and safety, being of primary importance, these should in no case be subordinated to aesthetics.
- d) Shrubs and trees should be planted clear of roadside drains and other drainage structures so that their root system do not interfere with efficient working of the drainage facilities.

To facilitate systematic execution of operations involved in roadside arboriculture, it will be advisable to prepare a detailed work plan including necessary drawings for field use. These should cover the scope and extent of the proposed activities, pattern, type and location of plantings, plant species to be used etc. and should be simple enough to be easily followed by field crews.

Tree plantation is the most effective, economical and useful remedy for control of environmental pollution. Besides, it is the cheapest way of landscape improvement. Trees have innumerable direct and indirect benefits of supplying timber and fuel at maturity. During their life time, they supply fodder, fruits, seeds, help in controlling soil erosion and

water conservation, offer shade and are oxygen producing industries to combat ever increasing air pollution. Big foliage trees also help in reducing noise and dust pollution.

### **1.6.1. OBJECTIVES OF TREE PLANTATIONS**

- i. To provide for aesthetic enhancement of the project corridors
- ii. To reduce the impacts of air pollution and dust, as trees and shrubs are known to be natural sink for air pollutants.
- iii. To provide much needed shade on glaring hot roads during summer.
- iv. To reduce the impact of ever increasing noise pollution caused due to increase in number of vehicles.
- v. To arrest soil erosion at the embankment slopes.
- vi. Prevention of glare from the headlight of incoming vehicles.
- vii. Climatic amelioration,
- viii. Moderating the effect of wind and incoming radiation
- ix. To define the ROW especially, to highlight sharp horizontal curves during night

### **1.6.2 SELECTION OF TREES FOR LANDSCAPING**

Trees, shrubs and climbers have been used to enhance the soft natural ambience against harsh elements in most of the enhancement schemes. The planting species are decided based on the physical growth characteristics of trees, like form and shape, foliage pattern, growth rate, branching pattern, soil characteristics and conditions of the strip like water logged areas etc. While selecting the species of trees for landscaping, great care should be taken to choose the species, which already exist along the project corridor.

The selection of plant types and planting arrangement should be based on the following considerations:

- i. Foliage and shade provision
- ii. Shape (spread of the tree) and size
- iii. Texture and colour of foliage/flower/fruits in different seasons and stages of growth.
- iv. Adaptability and suitability to agro-climatic regions/zones
- v. Growth rate (slow/fast) average age of maturity and replacement cycle
- vi. After-care and maintenance required for sustenance and growth
- vii. Economic and other social/recreational benefits

- viii. Drawbacks and demerits, if any, like prone to insects/pests disease, animal grazing and human interference.
- ix. Screening
- x. Plantation of pollution resistant dwarf shrub species in the median to prevent glare from the vehicles moving in opposite direction during night.
- xi. A mix of medium and large trees along roadside to screen the evening glare for the traffic moving towards west-northwest.
- xii. Screen plantation as a visual barrier in schools, hospitals, residential colonies, etc.
- xiii. Aesthetics
- xiv. Provision of flowering trees in the urban sections and major crossings
- xv. Provision of flowering shrubs in the median
- xvi. Softening of vertical surfaces of the retaining walls of grade separators and raised sections of the carriageway by climbers.

### **1.6.3 LOCATION OF TREES**

A soft landscape should be developed envisaging a holistic approach to the entire stretch. A concept should be evolved so as to maintain visual characteristics and uniformity in terms of landscape along the stretch. In the absence of uniform land availability for the plantations, different schemes may be worked out in tune with the local variations in the design. To achieve this, entire stretch of the project corridor should be divided into homogenous landscape sections based on similarity in terms of soil conditions, climate (temperature and rainfall) and topography. A study on the local flora and vegetative cover native to these sections should be carried out as part of the field surveys to enable the choice of suitable species for particular section.

Earlier, the first row of plantation along the highways used to be done by using tall shade bearing trees. But with the development of high-speed highways, the concept needs to be changed. For the sake of better road safety and for enhancing aesthetics, it has now been felt better to provide the shade plants in the last available row. In the first or the only available row; and other intermediary rows, small to medium sized ornamental trees should be planted.

The planting type should be decided based on the requirement and feasibility at various sites along the project corridor. Physical growth characteristics of trees, like form and shape, foliage and rooting characteristics, growth rate, canopy type and branching pattern are the major criteria in the selection of plantation type and density. The space available in the

ROW is one major guiding factor for different themes of landscaping applied in the entire corridor.

Depending on the available ROW, plantation pattern should be worked out as follows:

- a. The first row along the Highways will be of small to medium sized ornamental trees.
- b. Subsequent rows, depending on the availability of width, will comprise of ornamental and/or shade bearing species, of more height than those in the first row. In rural sections, the last row will always be of shade bearing tall trees.
- c. Planting of shrubs in the median.
- d. Planting of herbaceous species as ground cover in the median, special landscapes and embankment slopes.
- e. Turfing with grass in the median, special landscapes and embankment slopes.

#### **1.6.4 HIGHWAY LIGHTING:**

A primary purpose of lighting a roadway at night is to increase the visibility of the roadway and its immediate environment, thereby permitting the driver to maneuver more efficiently and safely. The visibility of an object is that property which makes it discernible from its surroundings.

##### **1.6.4.1 OBJECTIVES OF HIGHWAY LIGHTING:**

- To supplement vehicle headlights, extending the visibility range beyond their limits both laterally and longitudinally.
- To improve the visibility of roadway features and objects on or near the roadway.
- To delineate the roadway ahead. To provide visibility of the environment.
- To reduce the apprehension of those using the roadway

##### **1.6.4.2 TYPES OF LIGHTING:**

1. High Mast Lighting
2. Conventional Lighting
3. Sign Lighting

##### **1.6.4.3 BENEFITS OF HIGHWAY LIGHTING**

- There is a considerable reduction in accident rate during night because of proper lighting.
- The illegal and anti-social activities along roadway are greatly reduced
- Highway lighting is the major source of economic stimulation and beautification for their projects
- Increased business activities after addition of highway lighting

## UNIT- II HIGHWAY ENGINEERING

### 2.1 HIGHWAY ALIGNMENT AND SURVEYS:

#### 2.1.1 DEFINITION

The position or the layout of the center line of the highway on the ground is called the alignment. The horizontal alignment includes the straight path, the horizontal curves. The vertical alignment of roads includes changes in gradient and vertical curves. Alignment of a new road should be done carefully.

##### 2.1.1.1 DISADVANTAGE

If it is not properly aligned, it results in the following disadvantages.

- (a) Increase in construction cost
- (b) Increase in maintenance cost
- (c) Increase in vehicle operation cost
- (d) Increase in accident rate.

#### 2.1.2 PRINCIPLES OF IDEAL HIGHWAY ALIGNMENT

##### 2.1.2.1 BASIC REQUIREMENTS

The basic requirements of alignment between two stations are that it should be

1. Short
2. Easy
3. Safe and
4. Economical

(1) **Shortness:** The ideal alignment would suggest the shortest route linking the two terminal stations and as per definition, a straight line indicates the shortest distance between two points. Thus a straight alignment would grant the shortest distance between two points to be linked up by the proposed highway. Such a route will be cheap in construction as the length will be the shortest and also it will reduce the time of travel.

(2) **Easiness:** The highway alignment should be easy in the sense that it is possible to construct and maintain the road with practically no serious problems. It will also ensure smooth and comfortable operation of vehicles on gradients and curves.

(3) **Safety:** The aspect of safety should be viewed from two considerations, namely, before construction and after construction. The ideal alignment will ensure safety during the construction activities of highway. It will also be safe for carrying out the maintenance of highway and at the same time, it will allow the traffic movements safely and with confidence.

(4) **Economics:** The highway alignment should be selected in such a way that the total cost including initial cost, maintenance cost and operation cost is brought down to the minimum level. The economics of each alignment should be well studied after analyzing all the relevant

factors before making the final choice.

There are number of factors which are to be considered while selecting the alignment of roads. These factors also vary according to the type of roads and the areas through which these roads pass.

### 2.1.3 FACTORS INFLUENCING ALIGNMENT OF ROADS IN PLAIN AREAS.

Following are the factors which control the alignment of roads in plain areas.

- (1) **Class and Purpose:** The alignment of the road may be decided, keeping in mind the class and purpose of the road. National and state highways between two stations should be aligned as straight as possible. In other type of roads, if it is necessary the deviation may be permitted, if it is found necessary.
- (2) **Obligatory Points:** The roads are basically constructed for the development of the areas. Their alignment should necessarily pass through important towns, group of villages and places of worship, social, political and commercial importance by giving detour in regular alignment.
- (3) **Type of vehicular Traffic:** For fast moving traffic, the road alignment should be as straight as possible where as in case of bullock carts, ton gas etc, the alignment may even have sharp bunds.
- (4) **Gradient:** The alignment of roads should be such that longitudinal slopes are not steeper than ruling gradient. For this, alignment maybe deviated from straight path.
- (5) **Horizontal Curve:** The alignment should be provided with flat curves where ever found necessary. In case of national and state highways the radius of horizontal curves should not be less than 230 m. To have minimum radius the alignment must be changed.
- (6) **Sight Distance:** The alignment should be such that minimum sight distance is available for the drivers of the vehicles.
- (7) **Obstruction:** The alignment is decided, keeping in mind the obstructions. The alignment should be changed to avoid marshy land, ponds, wells, grave yards, historical, monumental and religious places etc.
- (8) **Cross Drainage Works:** The alignment should be such that minimum numbers of cross drainage works are required.
- (9) **Formation Bed:** The alignment should pass through stable soil which provides good formation bed.
- (10) **Bridges:** While crossing a river, the site should provide all the requirements needed for a good bridge construction. The alignment of the road should cross the river at  $90^\circ$  to avoid skew bridges.
- (11) **Railway Crossing:** A road alignment should cross a railway line preferably at  $90^\circ$ .



(12) **Earth work:** Alignment should be such that there is minimum earth work in cutting or filling.

(13) **Agricultural land and dense forests:** In alignment of road, the agricultural land and dense forest should be avoided as far as possible.

### 2.1.3.1 SPECIAL CONSIDERATIONS IN ALIGNMENT OF HILLY ROADS

In alignment of hill roads, special care should be taken to align the road along the side of the hill which is stable.

- a) **Drainage:** Hill side drains should be provided for adequate drainage facility across the road.
- b) **Geometric Standards:** The alignment of the hill road should be selected on the hill slope which easily provides recommended geometric standards. Hair pin bends should be avoided and if found necessary, these should be on gentle and stable slopes.
- c) **Resisting Length:** The resisting length of the alignment should be kept as low as possible.

### 2.1.4 SURVEY

#### 2.1.4.1 Traffic Surveys and Analysis

Information about traffic is indispensable for any road project since it would form the basis for the design of the pavement, fixing the number of traffic lanes, design of intersections and economic appraisal of the project, etc.

#### 2.1.4.2 Classified Traffic Volume Count

Count of traffic is the basic traffic study required in connection with many types of highway projects. A system of traffic census is in vogue in the country under which 7 day traffic counts are taken once or twice a year. When traffic census data from existing count stations are compiled, it may be found useful to collect past data (preferably about 10 years) so as to establish meaningful past growth trends for each vehicle class).

### 2.1.5 RECONNAISSANCE SURVEY

The main objective of reconnaissance survey is to examine the general character of the area for the purpose of determining the most feasible route among the routes. Data collected should be adequate to examine the feasibility of all the different routes in question, as also to furnish the Engineer-in-Charge with approximate estimates of quantities and costs, so as to enable him to decide on the most suitable alternative(s). The survey should also help in determining any deviations necessary in the basic geometric standards to be adopted for the highway facility.

### **2.1.5.1 PRELIMINARY SURVEY**

The preliminary survey is a relatively large scale instrument survey conducted on the route selected from reconnaissance for the purpose of collecting all the physical information which affects the proposed location of a new or existing highway. In the case of new roads, it consists of running an accurate traverse line along the route previously selected on the basis of the reconnaissance survey.

In the case of existing roads where only improvements are proposed, the survey line is run along the existing alignment. During this phase of the survey, topographic features and other features like houses, monuments, places of worship, cremation or burial grounds, utility lines, existing road and railway lines, stream, river, canal crossings are taken and bench marks established.

The data collected at this stage will form the basis for the determination of the final centre line of the road. For this reason, it is essential that every precaution should be taken to maintain a high degree of accuracy.

### **2.1.5.2 DETERMINATION OF FINAL CENTRE LINE**

Making use of the maps from preliminary survey showing the longitudinal profile, cross-sections and contours, a few alternative alignments for the final centerline of the road are drawn and studied and the best one satisfying the engineering, aesthetic and economic requirements is selected.

### **2.1.5.3 FINAL LOCATION AND DETAILED SURVEY**

The alignment finalized after the preliminary survey is to be translated on the ground by establishing the centerline. The line to be established in the field should follow as closely as practicable the line finalized after the preliminary survey and confirming the geometric design standards. The data collected during detailed survey should be elaborate and complete for preparing detailed plans and estimate of the project. Along the most desired route LS and CS and general contour survey are carried out. From these data the cost of the road and design parameters for gradient, curvature, sight distance, drainage and the location of bridges and culverts are worked out. The soil investigations are also carried out simultaneously to work out the foundation for the road formation. Further, the nearby available material which could be used for the construction is also identified. With these information a map is prepared for the guidance of the execution of the project by the project team.

### **2.1.6 DETAILED PROJECT REPORT**

The project data collected during the survey and investigations together with the estimates be worked out and presented for full appreciation by the appropriate authority. These should be prepared in the following three parts:

1. Estimate
2. Drawings
3. Report

### **1. Estimates**

The project estimate should give the financial implications of the project. The estimate should include all the items of execution from site clearance to finishing activities of the work. The estimate should include general abstract of cost and detailed estimate. The quantity of each item should be carefully worked out and expressed with the relevant units. The rates should be based on the schedule of rates applicable for the district. Wherever the rates are worked out, detailed analysis should be included in the estimates.

### **2. Drawings**

The following drawings are usually prepared:

- a) Key map
- b) Index map
- c) Preliminary survey plan
- d) Detailed plan and longitudinal section
- e) Detailed cross- section
- f) Land acquisition plans
- g) Detailed drawings of CD works
- h) Drawings of protection works and other structures
- i) Quarry chart

The cross section drawings should be extended at least up to the proposed right of way.

#### **2.1.6.1 HIGHWAY REALIGNMENT:**

Most of the highway projects constructed during pre-automobile era suffer from serious drawbacks for accommodating modern traffic conditions. Such defects include

- ❖ Single lane of traffic
- ❖ Steep gradients
- ❖ Sharp horizontal curves
- ❖ Inadequate sight distance

Highway re alignment is used to mean the modification of existing alignment in such a way that most of the defects of existing highway are removed or reduced to improve the performance of highway.

The construction of an entirely new highway involves substantial amount and hence, highway re

alignment projects prove quite satisfactory especially for existing highways.

Works in highway realignment project involves

- i. Construction of a bypass road to avoid major highway
- ii. Construction of over bridge or under bridges to avoid railway bridges
- iii. Improvement in design elements of the horizontal alignment such as elimination of reverse curves and undesirable zig-zags, shifting of curves etc.,
- iv. Improvement in vertical alignment such as correction of undesirable rise and falls, changes in summit curves etc.,
- v. Raising of highway subjected to flooding or water logging during monsoons
- vi. Replacing weak and narrow bridges
- vii. Entire alignment: The re alignment project should be framed for the whole alignment and not part of it.
- viii. Through traffic: If the town through which the highway passes has substantially developed and if the traffic terminating at town is quite small as compared to traffic going ahead then only the construction of a bypass road will be justified.
- ix. Water logging: The length of highway affected by water logging during monsoon should be clearly marked and it should be raised before strengthening or widening of pavement sections;

## 2.2 ROAD MACHINERIES:

The construction of major roads of large magnitude, plant and machinery of various types will be required. The use of modern sophisticated machineries has the following advantages:

- (i) The cost of highway maintenance is reduced.
- (ii) The highway construction is very fast; consequently the cost of the project is also considerably reduced.
- (iii) They ensure better and standardized quality of work.
- (iv) The useful life of highway structure is increased to a great extent due to high quality in construction.

The highway construction in modern days has received considerable attention and depending upon the several factors which rules the choice of highway making machineries, suitable plant and equipment for a particular project will have to be chosen.

### 2.2.1 EXCAVATING EQUIPMENTS

The process of cutting or loosening and removing earth from its original position, transporting and dumping it as a fill or spoil bank is known as excavation. It may be required for soil, soft rock or even hard rock before preparing the subgrade. The excavation will also be required for the construction of side drains. The choice of suitable excavation equipment will primarily depend on the nature of soil to be excavated. These are intermittent types of equipments. Tractors, power shovels, drag lines, clam shells, bulldozers, angle dozers, scrapers, back hoes, dredgers, ripper, motor grader, etc. are earth excavating equipments.

Machinery used for cutting, filling and for preparation of formation or sub grade is as follows.

1. Tractor
2. Dozer
3. Rooter
4. Rippers
5. Graders
6. Scrapers
7. Road roller

8. Mixer
9. Wheel borrows
10. Vibrator

#### 2.2.1.1 TRACTORS:

Tractors are used for different kinds of works. Tractors are generally fitted with various attachment such as dozers scraper etc.

This equipment is a self-propelled machine which is used mainly to exert a powerful tractive force for pulling other machines. When the tractor is not required for hauling other machines, it can be easily converted to serve as bulldozer, angle dozer, etc. The tractor may be crawler mounted or wheel mounted. In the former type, the tractors are supported on endless chain of plates and it is used for rough and uneven ground. In the latter type, the tractor is supported on wheels and it is used for even ground.

1. Track type tractor
2. Crawler type tractor



Fig. 2.2.1.1(1) Track - Type Tractor



Fig. 2.2.1.1(2) Crawler Type Tractor

### 2.2.1.2 DOZERS :

These are normally attached to a tractor for excavation of material and pushing the material.

Types of Dozers:

1. Bull Dozer
2. Angle Dozer
3. Tree Dozer

#### 1. BULL DOZER:

Bull Dozer is used for excavating the material and pushing the material in forward direction. It consists of blade attached to the front side of the tractor.

**1.1 PURPOSES OF BULLDOZER:** A bulldozer is very useful equipment and can be used on the construction work for the following purposes:

- (a) To clear the site of work,
- (b) To make the land level,
- (c) To prepare pilot roads through mountains and hard ground, and
- (d) To excavate the material and haul for a distance of about 100 metres.



Fig. 2.2.1.2(1) Bull Dozer

## 2. ANGLE DOZER:

Angle Dozer consists a blade attached to the tractor obliquely can be set at any angle to the direction of motion of the tractor. It is used to push the material to the side right or left.



Fig. 2.2.1.2(2) Angle Dozer

## 3. TREE DOZER:

Tree Dozer is used to uproot the trees.

### 3.1 ROOTERS OR RIPPERS:

Rooter is mounted on wheels and it is towed to a tractor and is used to remove stiff clay, soft rock or other hard soils.

This is an equipment which is sometimes attached to a tractor. It is mounted on the wheels and carries two to four teeth, the usual number being three. The ripper is used to break up the ground and to pull up the roots. This loosened material can then be removed by the scraper. With the aid of ripper, the scraper can be used for stiff clay, soft rock and such other material as can be ploughed.





Fig. 2.2.1.3 (3) Rippers

#### 2.2.1.3 SCRAPER:

This is mounted on wheels and drawn by a tractor. It consists a cutting edge to cut the earth and also consists a bowl to take in or throw out the cut earth.



Fig. 2.2.1.3 Scraper

#### 2.2.1.4 GRADER:

A grader is used to level the ground and spreads the loose material. It is a self-propelled or towed by a tractor. It consists of 3 to 4 m long angled blade supported on a framework mounted on wheels.



**Fig. 2.2.1.4 Grader**

## **2.2.2 COMPACTION EQUIPMENTS**

### **2.2.2.1 ROAD ROLLERS:**

Road rollers are used for compaction of sub grade base coarse etc.

The principle on which a road roller is working is the application of pressure which is slowly increased and is then gradually decreased.

### **2.2.2.2 TYPES AND DESCRIPTION**

Following are the types of Roller

1. Flat Wheeled Roller
2. Pneumatic type roller
3. Sheep foot roller

#### **1. FLAT WHEELED ROLLER**

A smooth wheeled roller or flat wheeled roller is a multi-purpose roller which is used for various purposes and for practically all types of roads. These rollers are suitable to compact a wide range of soils, preferably granular soils and pavement materials for the various layers. These rollers are particularly helpful in compacting soils and other materials where a crushing action is advantageous.

#### **2. PNEUMATIC TYPE ROLLER**

A pneumatic roller consists of a flat platform below which number of smooth rubber-tired wheels is mounted on two or more axles. The platform is then loaded with sand bags or some other weight and the roller is moved by tractor.

The rubber-tyred rollers are found to be very efficient in the compaction of earth subgrades, granular soils in base course, final operations for bituminous surface dressings, etc. In addition to the direct pressure due to rolling, these rollers also provide a slight kneading action.

### 3. SHEEPFOOT ROLLER

These are also known as tamping rollers. This type of roller consists of hollow steel cylinder or cylinders, each about 1.20 m long and 1.20 m in diameter with 180 mm to 230 mm projections extending out from the curved surface of the cylinder. These projections are made of steel and they resemble sheep's feet and are arranged in rows round the cylinders, the projections in successive rows being staggered. The weight of the roller can be increased by filling the drum with water or wet soil. As the roller is pulled forward over a layer of loose material, the projections penetrate the layer and compact the soil from top to bottom by kneading it. After a few rollings, the layer becomes more and more compact and the projections penetrate less and less in the rolled material. The roller is continued over the surface till the feet do not penetrate the soil.



**Fig. 2.2.2.1 Road Roller**

### 2.2.2.3 CONCRETE MIXER:

Concrete mixer of adequate capacity of the batch is provided. The mixer is equipped with a water measuring device. Concrete mixer is highly useful to prepare pavement concrete with thorough mixing at faster rate at site.



Fig. 2.2.2.3 Concrete Mixer

#### 2.2.2.4 WHEEL BORROW:

A wheel borrow consists two wheels and used to transport concrete for short distances from the mixer.



Fig. 2.2.2.4 Wheel Borrow

#### 2.2.2.5 VIBRATORS:

Vibrators are used to compact and consolidate the concrete. Vibrators facilitate the usage of concrete at right water cement ratio to produce dense and high strength concrete. Vibrators pack the ingredients of concrete densely through vibration expelling the air voids. Vibrators are of following three types

1. Surface vibrators
2. Internal vibrators
3. Needle vibrators.



**2.2.2.5(i) Surface Vibrator**



**2.2.2.5 (ii) Internal Vibrator**



**2.2.2.5(iii) Needle Vibrator**

### **2.2.3 EQUIPMENT FOR BITUMINOUS ROADS:**

For bituminous roads, it becomes necessary to heat the bitumen. Small projects and maintenance works; the aggregate filler and binder are heated together after being mixed dry in the required proportions and the binder or bitumen of the specified grade is heated to the required temperature and mixing is done on specially prepared platform at a central location from which the mix is carried to the site of placement by means of wheel barrows. The hot mixer of bitumen/Asphalt with aggregates is spread evenly on the clean prepared surface and compacted by the roller. The surface is next dusted on the top to fill up the small voids in the prepared surface and prevent the pavement sticking on the tyres of the moving vehicles.

The following equipments are used for the construction of the bituminous road.

1. Bitumen heaters
2. Bitumen Mixers
3. Bitumen truck mixers
4. Pavers

## 2.2.4 OTHER MACHINERIES FOR BITUMINOUS ROADS:

### 2.2.4.1 ROAD CLEANING MACHINE

Road cleaning machine are used to sweep roads quickly. This machine cleans the road completely and removes the dirt and dust from it in order to assist in road construction. This machine is provided with a rotary brush which mechanically operates and cleans the dust particles settled on the road



Fig.2.2.4.1 Road cleaning Machine

This machines is extensively used to clean the sand of the road with a powerful high pressure air blower within a short time there by it saves labour, time and also bitumen.



Fig.2.2.4.1 (a) Road cleaning Machine

### 2.2.4.5 ROAD KERBING MACHINE

A curb/kerb is the edge where a raised pavement/sidewalk/footpath, road median or road shoulder meets an unraised street or other roadway. Typically made from concrete, asphalt or

long stones (often granite), the purpose is twofold: first as a gutter for proper drainage of the roadway and second for safety, to prevent motorists from driving onto the shoulder, median, sidewalk or pavement.

Road kerbing equipment is widely used in various road projects. These concrete kerbing machine are built under strict guidelines as per international quality standards.



**Fig.2.2.4.2 Road Kerbing Machine**

### **2.2.4.3 ASPHALT PAVER FINISHER**

Mechanical Asphalt Paver Finisher is a unique paver with combination of features designed and engineered to give maximum output with comforts and efficiency. The hydraulically extendable screed allows step less and hassle free width adjustment. The higher H.P. engine ensures smooth paving in gradients. The paver can be employed for both asphalt as well as wet mix paving with slight modifications. Paver Finisher is used in road construction industry for paving or laying hot mix material on constructed surface. This is simple to operate and require negligible maintenance.



**Fig.2.2.4.3 Road Kerbing Machine**

#### 2.2.4.7 WET MIX PAVER

This is highly efficient and long lasting in nature. Wet Mix Pavers serve as an economical solution for laying wet mix Macadam and dry lean concrete.



www.binils.com  
Fig. 2.2.4.4 Wet mix Paver

#### 2.2.4.5 CHIPS SPREADER

Chip Spreaders is used for surface dressing works. It is used to lay 10mm to 65mm thick material. Chip Spreaders is available in two sizes as per given below:



Fig. 2.2.4.5 Road Kerbing Machine



#### 2.2.4.6 BITUMEN SPRAYER

Bitumen pressure distributor is developed for tack coat and between spraying application. This equipment is capable of applying a uniform coating of hot & emulsion bitumen on specified surface in prescribed quality..



Fig.2.2.4.6 Bitumen Sprayer

[www.binils.com](http://www.binils.com)

## **2.3 LOW COST ROADS:**

### **2.3.1 GENERAL**

Low cost road is used to mean the road whose initial as well as maintenance costs are low. The low cost roads are meant for low intensity of traffic. But at the same time, the following two precautions should be taken in the initial stage of development of such roads:

- (i) The geometric standard of low cost roads should be such that no alteration may be required when these roads are upgraded in future.
- (ii) With the increase in traffic, it should be possible to strengthen the pavement in stages with the maximum utilization of the existing pavement.

The low cost roads are constructed with the maximum use of locally available road materials. The science of soil mechanics has also proved to be helpful to the highway engineer for making reasonably stable low cost roads.

### **2.3.2 CLASSIFICATION**

#### **2.3.2.1 EARTH ROADS:**

It is made from the natural soil and is the cheapest type of road.

#### **METHOD OF CONSTRUCTION:**

- i. The borrow pits are normally selected outside the land width. The centre line is fixed and reference peg are driven.
- ii. The ground is cleared before excavating the soil
- iii. The sub grade is prepared and it is provided with necessary camber and longitudinal gradient. The maximum gradient for earth road is recommended as 1 in 20.
- iv. The sub grade is properly compacted before the laying of pavement layers commenced.
- v. The prepared earth is then mixed with water and laid in layers in such a way that the compacted thickness of each layer does not exceed 100 mm. It is usually laid in two layer.
- vi. The camber of the finished pavement surface is checked and it is corrected, if found necessary.
- vii. The compacted earth road is allowed to dry a period of 10 days before opening it for traffic.

#### **2.3.2.2 GRAVEL ROADS**

A gravel road consists of a carriageway made of a layer of compacted gravel. Gravel occurs naturally as rounded particles of many varieties of stone and it is usually associated with finer material which acts as a binder to hold the bigger material. These roads are superior to earth roads and as such, they are considered intermediate between earth roads and metalled roads.

**Following three considerations govern the construction of gravel roads:**

- i. **Drainage:** The carriageway of the gravel road should be provided with a camber of 1 in 25 to 1 in 30 to achieve good drainage of the road surface.
- ii. **Gravel:** It should be composed of pebbles which are hard, tough and durable rock particles to resist abrasion. The most durable pebbles come from quartz. But pebbles from hard limestone are also good material. The least durable pebbles are those from sandstones, shales or soft slates.
- iii. **Quality of binder:** For making a good road surface, the pebbles should be held together by some cementing material such as clay which is the most generally available binder. But certain gravels occur in nature in which pebbles are held together by either lime or iron oxides.

**METHOD OF CONSTRUCTION:**

- a) The material to be used for the construction of road is stacked along the sides of the proposed road. For obtaining a satisfactory gravel surface, the pebbles should be graded in size so as to form a good compact mixture with the addition of a small amount of binder.
- b) The pegs are driven to show the limits of excavation. The site is cleared and the subgrade is then prepared to receive the layer of gravel.
- c) The first layer of gravel is spread in the prepared trench. The compacted depth of gravel road is generally 200 mm and it is obtained in two layers, each of compacted thickness of about 100 mm. The layer is rolled by using smooth wheeled light rollers starting from the edges and proceeding towards the centre. Two rollers may be used on either side and rolling is done in such a way that an overlap of at least half the width of roller is obtained in the longitudinal direction. The use of rollers heavier than 8 tonnes for consolidation is not advisable as the gravel is found to get crushed or the surface to become wavy and corrugated. Some quantity of water is then sprayed and rolling is done again. It should be seen that the quantity of water to effect consolidation is just sufficient to secure a satisfactory bond between the pebbles and binder without softening the subgrade. The sprinkling of water should be done through a fine rose or nozzle.
- d) The camber is checked at intervals and it is corrected, if necessary, with the help of a template or a camber board.
- e) The final rolling is carried out when the moisture content is at its optimum so that the completed surface which is formed is firm and unyielding.
- f) There are two types of construction for a gravel road, namely, trench type and feather edge type.

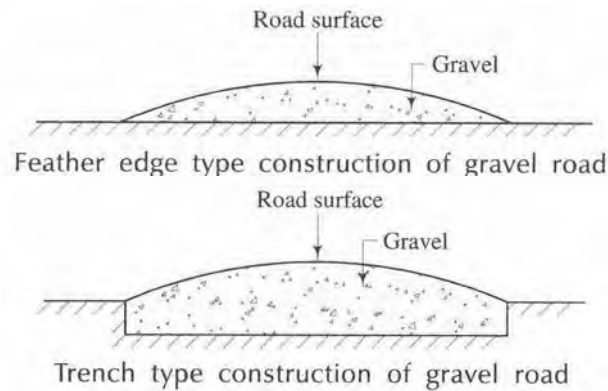
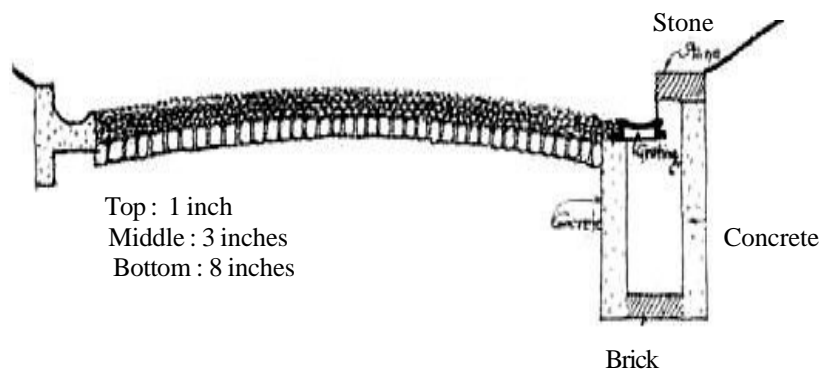

Fig. 2.3.2.2 Feather edge and Trench type gravel Road

g) A thin layer of sand of about 5 mm to 10 mm thickness is provided before opening the road to traffic. The newly made surface should be watched carefully for several months and defects developed under traffic should be corrected immediately.

#### 2.3.2.4 Water Bound Macadam (WBM)

WBM Consist of clean, crushed aggregates mechanically interlocked by rolling and bonding together with screening, binding material where necessary, and water laid on a properly prepared subgrade/sub-base/base or existing pavement, as the case may be and finished in accordance with the requirements of the specifications and in close conformity with the lines, grades, cross-sections and thickness as per approved plans or as directed by the Engineer.



The structure of the water bond macadam road consists of the following.

- (i) A foundation course of boulder stones placed on the compacted subgrade to thickness of about 25 cms
- (ii) A gravel layer of thickness 6 mm to 12 mm is placed at the top.

## **CONSTRUCTION PROCEDURE OF WATER BOND MACADAM**

### **(i) Preparation of foundation for receiving the WBM course**

The foundation for receiving the new layer of water bound macadam maybe either the sub grade or sub-base or base course. To this foundation layer required camber and grade are provided and the dust and other loose materials are removed.

### **(ii) Provision of Lateral Confinement**

Lateral confinement is done by constructing the shoulders in advance. Thickness of the shoulders are equal to that of compacted water bound macadam layer. The inner sides of the shoulders trimmed vertically.

### **(iii) Spreading of course aggregate**

The coarse aggregates which are stored along the road are spread uniformly and evenly upon the prepared base in required quantities. The aggregate should be spread to proper profile by using templates placed across the road about 6 m apart.

### **(iv) Rolling**

After spreading the course aggregate properly, compaction is done by a three wheeled power roller of capacity 6 to 10 tonnes. Rolling is started from the edges, the roller being run forward and backward until the edges are compacted. The run of the roller is then gradually shifted towards the centre line of the road, uniformly overlapping each preceding rear wheel track by one-half width. This process is repeated until required compaction is achieved.

On super elevated portions of the road, rolling is started from the inner edge and progressed gradually towards outer edge of the road.

### **(vi) Application of screenings**

After rolling, screenings are applied over the surface to fill the voids in three or more applications, after screenings are applied dry rolling should be continued.

### **(vii) Sprinkling and Grouting**

After the application of screenings, the surface is sprinkled with water, swept and rolled. Wet screenings are swept into voids using hand brooms. Additional screenings are applied and rolled till the coarse aggregates are well bonded and firmly set.

### **(viii) Application of binding material**

Binding material is applied after the application of screenings. Binding material is applied at a uniform slow rate in two or three thin layers, after application of binding materials, the surface is sprinkled with water and slurry swept with brooms to fill the voids. This is followed by rolling with a 6 to 10 tonne roller.

#### (ix) Setting and Drying

The surface is allowed to set over night. If depressions are found on the next day, they are filled up with screenings or binding material if necessary after lightly sprinkling with water they are rolled.

### 2.3.3 THE MAINTENANCE OF WBM ROADS

- It consists of replacing the soil binder periodically to prevent the aggregate from getting loosened from the surface course.
- Providing bituminous surface dressing to prevent dust.
- Patch work of pot holes and ruts formed. The patch repair work is carried out by first cutting at a rectangular shape of the defective area. Then with the coarse aggregate of the same size the patch is filled up and well compacted.

### 2.3.4 SOIL STABILIZATION

Sometimes soil/soil-gravel/aggregates and waste materials such as fly ash, iron and steel slag and other such materials, available in the near vicinity of the construction sites do not conform to the grading, PI and strength requirements. Such inferior materials can be improved by adopting soil stabilization technique. The methods of stabilization can be broadly grouped as:

1. Mechanical Stabilization
2. Lime Stabilization
3. Cement Stabilization
4. Lime- flyash stabilization
5. Bitumen stabilization
6. Two -stage stabilization

A variety of techniques are available for stabilizing local soils for improving their engineering properties, but not all the techniques are applicable to all types of soils. Soil stabilization requires choosing the most appropriate technique for stabilizing the soil at site. The mix proportions are generally worked out in the laboratory based on soaked CBR.

## **2.4 BITUMINOUS ROAD**

### **2.4.1 INTRODUCTION**

Bitumen road is a road constructed by bitumen. Bitumen is black viscous mixture of hydrocarbons obtained by distillation of petroleum. Previously Tar was also used in construction of bituminous roads, as the tar was susceptible for high temperatures, bitumen replaced tar in road construction. Bitumen roads are flexible pavements consists of subgrade, sub-base course, base course and a bituminous surface course.

Even though all bituminous materials are black in color and are composed mainly of bitumen, their physical properties differ greatly.

Bituminous materials are classified into two main groups by origin:

1. Asphalts and 2. Tars.

These are the two bituminous materials used in the construction of roads and airfields.

### **2.4.2 ADVANTAGES AND DISADVANTAGES**

#### **2.4.2.1 ADVANTAGES**

##### **1. Improvements to Driving Surface**

A particular advantage to bituminous stabilization is that the driving surface is greatly improved.

The gravel surface is effectively bound with the asphalt emulsion, and with one or two seal coat layers after the stabilization process, the surface roughness is greatly reduced. In addition, the probability of airborne gravel particles striking a vehicle while driving behind another vehicle is greatly reduced. There are some disadvantages to this improved driving surface, which will be discussed in a following section.

##### **2. Elimination of Dust**

By binding the aggregate with asphalt emulsion, the dust that is normally associated with an aggregate-surfaced road is virtually eliminated. In addition to the elimination of dust, this also means that mud is eliminated during rain events.

##### **3. Reduction in Loss of Aggregate**

Another benefit to binding the surface layer with asphalt emulsion is that the aggregates in the surface are not lost in the ditches and are less likely to degrade and be crushed due to the action of vehicle tires and of the environment. The loss of aggregate is one of a highway agency's major expenditures for roadway maintenance of aggregate surfaced roads. The clear benefits to dramatically reducing the amount of lost aggregates include cost savings as well as using less of a limited resource that seems to be getting more and more difficult to find.

#### **2.4.2.2 DISADVANTAGES**

While there are many benefits to upgrading a gravel roadway with bituminous stabilization, there are also some disadvantages that must be considered. These include the following.

1. Potential to induce higher driving speeds and thus, potentially dangerous curves in existing geometry
2. Potential distresses

#### **2.4.3 BITUMINOUS MATERIALS**

Bitumen is defined as “A viscous liquid, or a solid, consisting essentially of hydrocarbons and their derivatives, which is soluble in trichloro- ethylene and is substantially nonvolatile and softens gradually when heated. It is black or brown in colour and possesses waterproofing and adhesive properties. It is obtained by refinery processes from petroleum, and is also found as a natural deposit or as a component of naturally occurring asphalt, in which it is associated with mineral matter.

[www.binils.com](http://www.binils.com)

##### **2.4.3.1 CLASSIFICATION OF BITUMINOUS BINDER**

Bitumen or bituminous binder available in India is mainly of the following types:

##### **1. PENETRATION GRADE: BITUMEN 80/100:**

The characteristics of this grade confirm to that of S 90 grade of IS-73-1992. This is the softest of all grades available in India. This is suitable for low volume roads and is still widely used in the country.

##### **2. BITUMEN 60/70:**

This grade is harder than 80/100 and can withstand higher traffic loads. The characteristics of this grade confirm to that of S 65 grade of IS- 73-1992. It is presently used mainly in construction of National Highways & State Highways.

##### **3. BITUMEN 30/40:**

This is the hardest of all the grades and can withstand very heavy traffic loads. The characteristics of this grade confirm to that of S 35 grade of IS-73-1992. Bitumen 30/40 is used in specialized applications like airport runways and also in very heavy traffic volume roads in coastal cities in the country.



#### 4. VISCOSITY GRADE BITUMEN:

The new method of grading the product has now rested on the viscosity of the Bitumen (at 60<sup>0</sup>C and 135 <sup>0</sup>C). IS 73:2006 has been released by Bureau of Indian Standards. Three grades of Bitumen conforming to IS 73: 1992 are manufactured in India. **In this third revision grading of Bitumen is changed from penetration grade to viscosity grade.** To improve the quality of Bitumen, BIS revised IS-73-1992 Specifications based on viscosity grade (viscosity @ 60 deg. C) in July 2006. As per the Specifications, there are four grades VG-10, VG-20, VG-30 & VG-40.

The new grades have thus evolved with nomenclature:

Grades	Minimum of Absolute viscosity, Poise@ 600C	Approximate penetration grade
VG 10	800	80-100
VG 20	1600	_____
VG 30	2400	60-70
VG 40	3200	30-

#### 5. CUTBACK BITUMEN

Cutback is a free flowing liquid at normal temperatures and is obtained by fluxing bitumen with suitable solvents. The viscosity of bitumen is reduced substantially by adding kerosene or any other solvent. Cutback has been used in tack coat applications. Cut-back bitumen is used for cold weather bituminous road construction and maintenance. The petroleum distillates used for preparing cut-back bitumens are naphtha, kerosene, diesel oil, furnace oil or heavy distillate. There are different types of cut-back bitumen like the Rapid Curing (RC), Medium Curing (MC) and Slow Curing (SC). Rapid curing cut-back bitumen is recommended for the surface dressing in cold weather and patch repair work. Medium curing cut-back bitumen is in premix with less quantity of fine aggregate. Slow curing cut-back bitumen is used in premix containing appreciable quantity of fine aggregates.

#### 2.4.4 TYPES OF BITUMEN ROADS

Number of types and methods are in use for bituminous pavement construction.

Following are the types of bitumen roads based on the methods of construction.

1. Interface treatments like prime coat and tack coat.
2. Surface dressing
3. Seal coat
4. Grouted or penetration type constructions.
5. Full grout
6. Semi grout constructions
7. Premix construction
8. Interface Treatment

### 1. INTERFACE TREATMENTS LIKE PRIME COAT AND TACK COAT

Before construction of any type of bituminous layer over a surface, the surface of the existing pavement layer is to be cleaned and a thin layer of bituminous binder is to be sprayed. This treatment with bituminous material is called interface treatment and it is necessary to provide the bond between the old and the new layers. The interface treatment may be either a prime coat or tack coat and in some cases, the prime coat followed by a tack coat.

(i) **Prime Coat:** Prime coat is the first application of a low viscosity liquid bituminous material over an existing porous pavement surface like the WBM base course. The main object of prime coat is to plug the voids of the porous surface and to bond the loose mineral particles on the existing surface, using a binder of low viscosity which can penetrate into the voids. The prime coated surface is allowed to cure for at least 24 hours.

(ii) **Tack Coat:** Tack coat is the application of bituminous material over an existing pavement surface which is relatively impervious like an existing bituminous surface or a WBM surface which has already been treated by a prime coat.

### 2. SURFACE DRESSING

Bituminous surface dressing is provided over an existing pavement to serve as thin wearing course. The single coat surface dressing consists of a single application of bituminous binder material followed by spreading of aggregate cover and rolling. If the surface dressing is done in two layers, it is called two coat bituminous surface dressing. The main purpose of bituminous surface dressing are :

- To serve as wearing course and to protect base course
- To prevent infiltration of surface water
- To provide dust free pavement surface in dry weather and mud-free pavement in wet weather.

### 3. SEAL COAT

Sealcoat is a very thin surface treatment or a single coat surface dressing which is usually applied over an existing black top surface. Seal coat is usually recommended as a top coat over certain bituminous pavements which are not impervious. The main functions of seal coat are

- To seal the surface against percolation of water
- To develop skid resistant texture
- To improve an existing dry or weathered bituminous surface.

### 4. GROUTED OR PENETRATION MACADAM

Bituminous grouted Macadam or penetration macadam is used as a base or binder coarse. The coarse aggregates are first spread and compacted well in dry state and after that hot bituminous binder of relatively high viscosity is sprayed in fairly large quantity at the top. The bitumen penetrates into the voids from the surface of the compacted aggregates, the bitumen fills the voids and binds stone aggregates together.

Depending upon the quantity of bitumen spread and the extent of penetrated the grouted macadam are two types (a) full-grout and (b) Semi-grout

**5. FULL GROUT:** When bitumen penetrated to full depth of compacted aggregate it is called full grout macadam. Full grout is adopted in regions of heavy rainfall and high traffic.

**6. SEMI-GROUT:** When bitumen penetrates up to about half depth of compacted aggregate it is called semi-grout macadam. Semi-grout macadam is adopted in regions of moderate rainfall and traffic.

### 7. PREMIX

The aggregates and the bitumen are mixed thoroughly before spreading and compacting. It is possible to coat each aggregate particle with less quantity of bitumen binder.

The following are common premix methods.

- a. Bituminous macadam
- b. Bituminous carpet
- c. Bituminous Concrete or Asphalt concrete
- d. Sheet Asphalt.

#### 2.4.5 CONSTRUCTION PROCEDURE OF BITUMINOUS MACADAM

The Bituminous Macadam (BM) is a remix laid immediately after mixing and then compacted. It is suitable only as a base course or binder course. When this course is exposed as a surface course, at least a seal coat is necessary. The construction procedure consists following steps:

**(i) Preparation of existing layer:** The existing layer is prepared to a proper profile. Pot holes are patched and irregularities are made free. The surface is cleared and made free from dust and other organic material.

**(ii) Tack coat application:** A tack coat is applied in thin layer of bitumen binder with the help of mechanical sprayer or a pouring can.

**(iii) Preparation of Premix:** The bitumen and aggregates as per recommended grading are separately heated to the specified temperatures and are placed in the mixer. The mixing temperatures also specified. The mixing is done till a homogenous mixture is obtained. The mixture is then carried to the site for its placement.

**(iv) Placement:** The premix mixer is then immediately placed on the desired location and is spread to specified thickness. The camber profile is checked with a template. It should be seen that minimum time is spent between the placement of the mix and the rolling operation.

**(v) Rolling and finishing the paving mix:** The rolling is done with 8 to 10 tones tandem roller. The rolling is started from the edges towards the center and uniform overlapping is provided. The finished surface should not show separate lines of markings due to the defective rolling. The roller wheels are kept damp, otherwise the paving mix may stick to the wheels and finishing may not be good.

#### 2.4.6 CONSTRUCTION PROCEDURE OF BITUMINOUS CONCRETE

The bituminous concrete is the highest quality of construction of bituminous roads. The bituminous mixes are properly designed to the specification. The mixture contains dense course aggregate, fine aggregate and mineral filler coated with bituminous binder. The mix is prepared in hot-mix plant.

**(i) Preparation of the existing base course layer :** The base course is made true to camber and grade. Pot holes and depressions are filled with premix chippings.

**(ii) Application of Tack coat :** The heated bitumen is sprayed at 6.0 to 7.5 kg per 10m<sup>2</sup> area, just before spreading the premix.

**(iii) Preparation and placing the premix :** The premix is prepared in hot mix plant with the desired quality. The hot mixed material is collected from the mixer by the transporters,

carried to the location and is spread by a mechanical paver. The camber and the thickness of the layer are accurately checked.

**(iv) Rolling :** After placing the mix on the base course, it is rolled and thoroughly compacted by 8 to 10 tonnes wheeled roller at a speed not more than 5 km per hour. The wheels of the roller are kept damp with water. The number of passes required depends on the thickness of the layer.

**(v) Finishing and opening to traffic :** The surface is to be checked for camber and depressions if any are rectified.

**(vi) Opening to traffic :** The surface is to be opened to traffic after 24 hours of laying the finished surface.

#### 2.4.7 MAINTENANCE OF BITUMINOUS SURFACES

A bituminous surface wears out due to (i) traffic (ii) weather, such as ingress of water, loss of volatiles in the binder and oxidation of binder (iii) inadequacies in the initial specifications and construction standards. Table 2.4.7 lists out for each type of distress, symptoms, probable causes and possible types of treatments (IRC).

[www.binils.com](http://www.binils.com)

Table: 2.4.7 Symptoms, causes and treatment of defects in bituminous surfacing

Types of	Symptoms	Probable Causes	Possible types of
<b>A. Surface defect</b>	Collection of binder on the surface	Excessive binder in premix, spray or tack coat; loss of cover aggregates, excessively heavy axle load.	Sand-blinding; open-graded premix; liquid seal coat; burning of excess binder; removal of affected area.
1. Fatty surface			
2. Smooth surface	Slippery or excessive binder.	Polishing of aggregates under traffic, Resurfacing with surface dressing or premix carpet.	
3. Streaking	Presence of alternate lean and heavy lines of bitumen	Non-uniform application of bitumen, or at a low temperature.	Application of a new surface.
4. Hungry surface	Loss of aggregates or presence of fine cracks	Use of less bitumen or absorptive aggregates	Slurry seal or fog seal.
<b>B. Cracks</b>			
1. Hair-line cracks	Short and fine cracks at close intervals on the surface	Insufficient bitumen, excessive filler or improper compaction.	The treatment will depend on whether pavement is structurally sound or unsound.
2. Alligator cracks	Inter-connected cracks forming series of small blocks.	Weak pavement, unstable conditions of subgrade or lower layers, excessive	Where the pavement is structurally sound, the cracks should be filled

3. Longitudinal cracks	Cracks on a straight line along the road	overloads or brittleness of binder.  Poor drainage, shoulder settlement, weak joint between adjoining spreads of pavement layers or of differential frost heave.	with a low viscosity binder or a slurry seal or fog seal depending on the width of cracks.  Unsound cracked pavements will need strengthening or rehabilitation treatment.
4. Edge cracks	Cracks near and parallel to pavement edge	Lack of support from shoulder, poor drainage, frost heave, or inadequate pavement width	
5. Shrinkage cracks	Cracks in transverse direction or inter-connected cracks forming a series of large blocks.	Shrinkage of bituminous layer with age.	
6. Reflection cracks	Sympathetic cracks over joints and cracks in the pavement underneath.	Due to joints and cracks in the pavement layer underneath	
<b>C. Deformation</b>			
1. Slippage	Formation of crescent shaped cracks pointing in the direction of the thrust of wheels	Unusual thrust of wheels in a direction, lack or failure of bond between surface and lower pavement courses.	Removal of the surface layer in the affected area and replacement with fresh material.

2. Rutting	Longitudinal depression in the wheel tracks	Heavy channelized traffic, inadequate compaction of pavement layers, poor stability of pavement material or heavy bullock cart traffic.	Filling the depressions with premix material.
3. Corrugations	Formation of regular undulations	Lack of stability in the mix, oscillations set up by vehicle springs, or faulty laying of surface course.	Scarification and relaying of surfacing, or cutting of high spots and filling of low spots.
4. Shoving	Localized bulging of pavement surface along with crescent shaped cracks	Unstable mix, lack of bond between layers, or heavy start-up type movements and those involving negotiations of curves and gradients.	Removing the material to firm base and relaying a stable mix.
5. Shallow depression	Localized shallow depressions	Presence of inadequately compacted pockets.	Filling with premix materials.
6. Settlement and upheaval	Large deformation of pavement	Poor compaction of fills, poor drainage, inadequate pavement or frost heave.	Where fill is weak the defective fill should be excavated and redone. Where inadequate pavement is the cause, the pavement should be strengthened.
<b>d. Disintegration</b> 1. Stripping	Separation of bitumen from aggregates in the presence of moisture	Use of hydrophilic aggregates, inadequate mix composition, continuous contact with water, poor bond between	Spreading and compacting heated sand over the affected area in the case of surface dressing,



		aggregate and bitumen at the time of construction etc.	replacement with fresh bituminous mix with added anti-stripping agent in other cases.
2. Loss of aggregate	Rough surface with loss of aggregate in some portions.	Ageing and hardening of binder and aggregate, poor compaction etc.	Application of liquid seal, fog seal or slurry seal depending on the extent of damage.
3. Ravelling	Failure of binder to hold the aggregates shown up by pock marks of eroded areas on the surface.	Poor compaction, poor bond between binder and aggregate, insufficient binder, brittleness of binder etc.	Application of cutback covered with coarse sand, or slurry seal, or a premix renewal coat.
4. Pot-hole	Appearance of bowl-shaped holes, usually after rain	Ingress of water into the pavement, lack of bond between the surfacing and WBM base, insufficient bitumen content etc.	Filling pot-holes with premix material, or penetration patching.
5. Edge-breaking	Irregular breakage of pavement edge.	Water infiltration, poor lateral support from shoulders, inadequate strength of pavement edges, etc..	Cutting the affected area to regular sections and rebuilding with simultaneous attention paid to the proper construction of shoulders.

#### **2.4.7.1 Pot-Hole Repair (Patch Repair)**

The amount of patching needed to make up pot-holes and localized failures may vary from 0 to 25 per cent of the surface area annually. Patching prolongs the surface life until a time will come when it will be more economical and desirable to renew the surface entirely.

Patching can be done by (i) sand premix, (ii) open-graded premix (iii) dense-graded premix (iv) penetration patching or (v) surface dressing. Dense-graded premix patch is rarely used, only where the existing surface itself is dense-graded asphaltic concrete. Surface dressing (one or two coats) can be done for existing surfaces with a similar specification and where the traffic is not too heavy.

[www.binils.com](http://www.binils.com)

## **2.5 CEMENT CONCRETE ROADS:**

### **2.5.1 GENERAL**

The cement concrete roads have a very high recognition due to the excellent riding surface and pleasing appearance. The life of the cement concrete road is much more than any other type of road. The maintenance cost of the concrete road is very less when compared with other roads.

### **2.5.2 ADVANTAGES AND DISADVANTAGES**

#### **2.5.2.1 ADVANTAGES**

Following are the advantages of a cement concrete road:

- i. It can, be designed more accurately for load distribution.
- ii. It does not develop corrugations and hence, it grants noiseless surface.
- iii. It has good visibility at night due to colour contrast.
- iv. It has low cost of maintenance.
- v. It has low tractive resistance which diminishes the cost of running of vehicles.
- vi. It has more useful life than road of any other type of construction.
- vii. It is dustless and has no internal attrition.
- viii. It is not unduly slippery.
- ix. It is possible to make it resistant to severe stresses and strains caused under unfavourable soil and temperature conditions by placing suitable reinforcements.
- x. It is possible to make use of old concrete road as a base or foundation for a new concrete road or for further bituminous treatment at the top.
- xi. It is practically unaffected by weather and temperature.
- xii. It permits the calculation of super-elevation on curves with more mathematical accuracy than other types of roads.
- xiii. It requires flat camber as the surface is impermeable

#### **2.5.2.2 DISADVANTAGES OF CEMENT CONCRETE ROADS**

Following are the disadvantages of a cement concrete road:

- (i) It causes the surface to shine in severe sunlight and the white glare reflected from surface may disturb the concentration of driver causing serious accident.
- (ii) It does not permit easy access to the subsoil when trenches have to be opened to locate water mains, sewers and electric cables.
- (iii) It is difficult to repair and needs expert supervision.
- (iv) It is less resilient than W.B.M. or bituminous binder surfaces.

(v) It is liable to crack, warp and twist.

(vi) It is noisy under iron-tired traffic and vibrations are set up by heavy, rapid-moving and self-propelled vehicles.

(vii) It proves to be very expensive in initial cost especially when a suitable local aggregate is not available.

(viii) It reacts more readily because of its rigidity to stresses and strains caused by impact and may therefore crush under such conditions.

The cement concrete roads requires very high initial investment and the method is not suitable for stage construction. The cement concrete roads are constructed with or without the sub-base course.

### **2.5.3 CONSTRUCTION OF CEMENT CONCRETE ROAD**

The construction of cement concrete roads is carried out in the following groups.

1. Construction of pavement (Road) Slab
2. Construction of joints.

### **2.5.4 METHOD (OR) TYPE OF CONSTRUCTION**

Types of construction of cement concrete roads

The following are the two methods of construction of CC roads.

1. Alternate bay method
2. Continuous bay method.

#### **2.5.4.1 Alternate Bay Method**

In alternate bay method, alternate concrete slabs are laid. The subsequent slabs are laid subsequently.

In alternate bay construction, the slabs constructed are in sequence of AB'Cs etc. leaving gaps of bay A'B and C' etc.

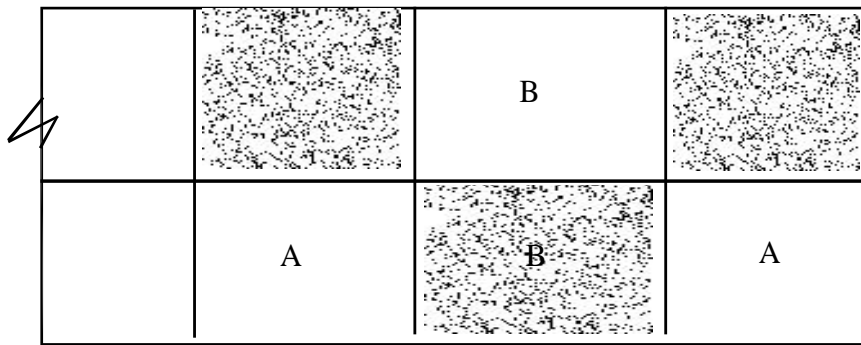

Fig. 2.5.4.1 Method of laying concrete road

#### 2.5.4.2 CONTINUOUS BAY METHOD :

In this may all the slab bays are laid in sequence ie. ABC or A'B'C'.

#### 2.5.5 CONSTRUCTION OF CEMENT CONCRETE SLABS

Following are the steps in construction of C.C. slabs.

- i. Preparation of sub grade and sub base
- ii. Placing of forms
- iii. Batching of material and mixing
- iv. Transportation and placing of concrete
- v. Compaction and finishing
- vi. Floating and straight edging
- vii. Curing of cement concrete.

##### (i) PREPARATION OF SUB GRADE AND SUB BASE

The sub grade or sub base for laying the concrete should be well compacted as per the requirement and should extend at least 300 mm on either side of the width to be concreted. The subgrade should be prepared and checked at least two days before the concreting pipes of the sufficient diameter and provided where ever cables are taken across road.

##### (ii) PLACING OF FORMS

The wooden or steel forms are used for the purpose. Wooden forms are dressed on one side and have minimum width of 100 mm for slab thickness of 200 mm. Depth should be equal to the thickness of the pavement. The forms are joined neatly and are set true to the required grade and alignment. The forms should be rigidly fixed such that they do not deviate during the entire operation compacting and finishing. The tolerance allowed maybe 3 mm from a straight edge 3 m in length.

The steel forms are of usually M.S. channel sections and their depth should be equal to the thickness of the pavement. When set to grade the maximum deviation of the top surface of any section from a straight line is not exceeded by 3 mm.

### **(iii) BATCHING OF MATERIAL AND MIXING**

The fine aggregate and coarse aggregates for the concrete should be properly proportioned by weight in a weight batching plant and placed in to the hopper along with the necessary quantity of cement. The mixing of concrete is done in batch, which will ensure a uniform distribution of the materials throughout the mass, so that the mix is uniform in colour and homogenous.

### **(iv) TRANSPORTATION AND PLACING OF CONCRETE**

The cement concrete should be mixed in quantities required for the immediate use. The concrete should be placed within the form work correct to the depth. While placing there should be no bleeding and segregation. The mix concrete should be placed within 30 minutes.

### **(v) COMPACTION AND FINISHING**

The surface of the pavement is compacted either by means of a power driven finishing machine or by a vibrating hand screed. For areas where the width of the slab is very small, hand compaction and finishing may be adopted. As soon as the concrete is placed, it should be uniformly spread to the required cross section of the pavement to conform the grade.

### **(vi) FLOATING AND STRAIGHT EDGING**

The concrete is further compacted by means of longitudinal float. The longitudinal float which is 1.2 m long and 75 mm wide wooden log held in position parallel to carriage way centre line and passed gradually from one side of a pavement to other. After the compacted the surface is tested for grade and level with straight edge.

**(a) Belting:** Just before the concrete becomes hard, the surface is bolted with a two ply canvas belt. The short strokes are applied transversely to the carriage way.

**(b) Brooming :** After belting, the pavement is given a broom finish with steel or fibre broom brush. Brooming is done perpendicular to the centre line of the pavement.

### **(vii) CURING OF CEMENT CONCRETE**

**(a)Initial curing :** The surface of the finished pavement shall be entirely covered with the wet jute mats. The covering is maintained fully wetted for 24 hours.

**(b)Final Curing :** The final curing is done with any one of the following methods.

Curing with wet soil, clay bounds 75 mm wide and 75 mm high may be laid forming squares all over the surface. The surface is flooded with water up to a depth of 20 to 50 mm.

(c) Impervious membrane : The object of this type of curing is to prevent evaporation. This type of curing is done by the membrane which consists of a colorless impervious liquid. This liquid is applied immediately after the finishing of the surface and before the set of the cement.

### 2.5.5 JOINTS IN CEMENT CONCRETE ROAD

Joints in Cement concrete roads (Longitudinal joints – Transverse joints – Construction joints

#### 1. Longitudinal joints

Longitudinal joints are provided in cement concrete roads with a width over 4.5m. The longitudinal joints are provided to prevent longitudinal cracking in the cement concrete pavements. Longitudinal joint acts as a hinge and helps to maintain two slabs together at the same level. The various types of longitudinal joints are shown in figure.

#### 2. Transverse joints

Transverse joints are classified as

- i. Expansion joint
- ii. Contraction joint
- iii. Warping joint

(i) **Expansion joint:** Expansion joints are obtained to allow expansion of the slabs due to increase in slabs temperature. These joints also permit the contraction of slabs. In India expansion joints are provided at an interval of 50 to 60 m for roads laid in winter and 90 to 120 m for roads laid in summer and typical expansion joint is shown in figure.

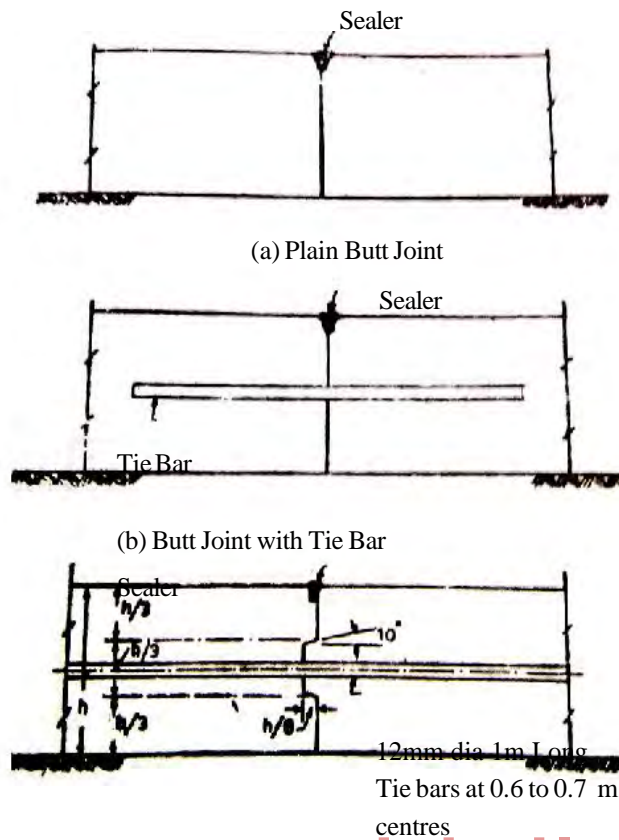

Fig 2.5.6(1) Longitudinal Joints

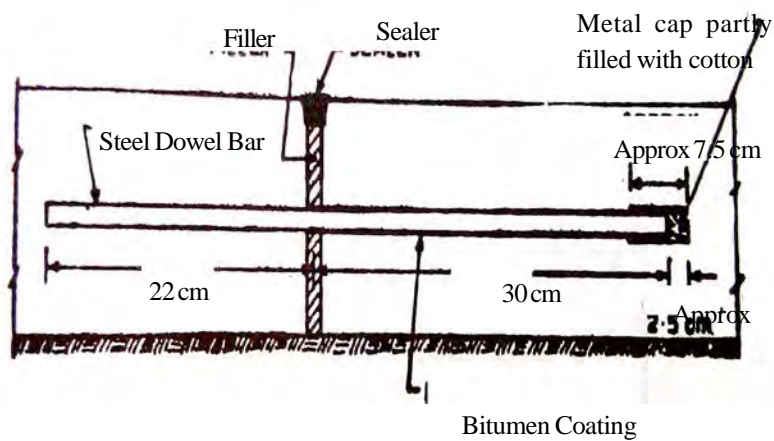
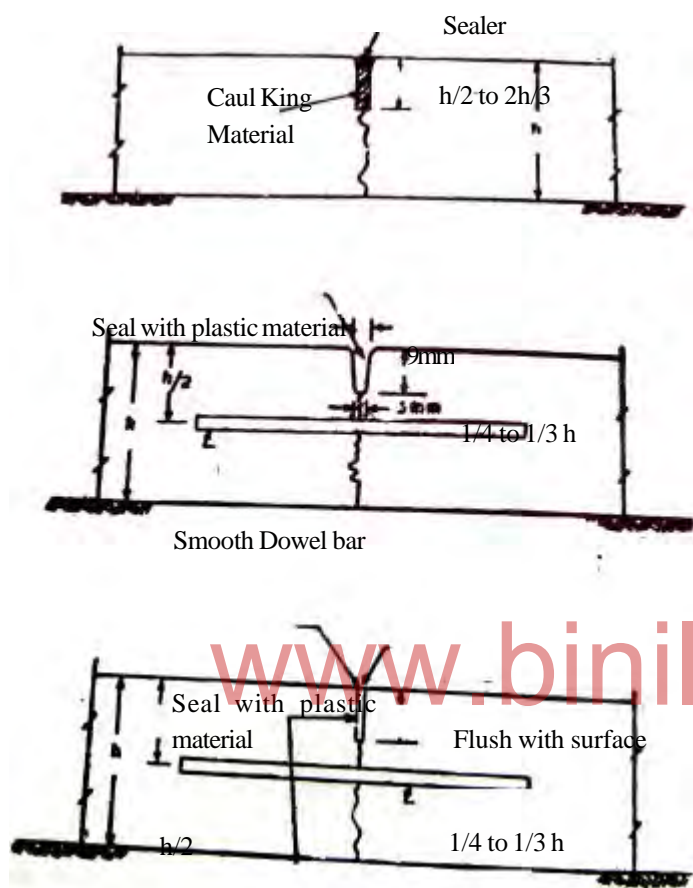

Fig. 2.5.6.2(i) Expansion Joint with Dowel Bar



**(ii) CONTRACTION JOINT:** Contraction joints are provided to permit the contraction of the slab. These joints are spaced closer than expansion joints. As per IRC specifications the maximum spacing of contraction joints in un reinforced CC slabs is 4.5 m and in reinforced slabs is 14 m. Typical contraction joint is shown in fig below.



**Fig 2.5.6.2(ii) Contraction Joint**

**(iii) WARPING JOINT:** The warping joints are known as hinged joints are provided to relieve stresses included due to warping. Longitudinal joints provided with the bars belong to this type of joints. These joints are not needed if the suitable expansion and contraction joints are provided.

### 3. CONSTRUCTION JOINTS

In cement concrete road construction apart from expansion joints and contraction joints construction joints are also provided. The compulsory break provided in continuity of the slabs is due to close of days work and the commencement of the same, the next day with a construction joint. Normally the construction joint is planned to coincide with an expansion joint.

Location of the above discussed joints are shown in fig given below

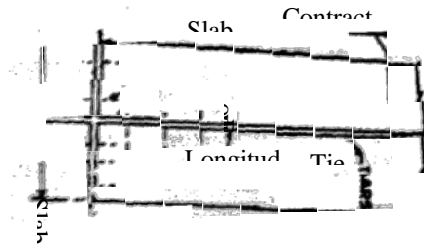

Fig. 2.5.6 Location of Joints

[www.binils.com](http://www.binils.com)

## **2.6 HILL ROADS**

### **2.6.1 DEFINITION**

The most difficult areas of the hills in our country are the one on the Himalayas which are probably the youngest folded mountains in the world. The highest peaks in the world are situated in these areas. The mountains contain steep slopes and they consist of a number of criss-cross ridges and valleys and hence, in order to go from one place to another, it is required to cover long distances and cross a number of ridges, valleys, rivers and other small torrents.

Border Roads Organization was formed in the year 1958, with the objective of deciding the policies of construction of strategic roads along the northern hill regions of the country. The groundwork of this organization started in September 1960 and the work was commenced in July 1961. This organization has done excellent work in laying a network of roads in almost inaccessible areas extending from eastern region like NEFA to northern region in Jammu and Kashmir. This organization in fact has accomplished the huge task of developing roads in hilly areas of our country.

The term hill road can be explained with reference to the cross slope, i.e., the slope approximately perpendicular to the centre-line of the highway alignment. Thus a road is termed as a hill road if it passes through a terrain with a cross slope of 25 per cent or more and it is characterized by widely differing elevations, deep gorges, number of water courses and steep slopes. The hill roads are also sometimes referred to as ghat roads.

### **2.6.2 FACTORS CONSIDERED IN ALIGNMENT OF HILL ROADS**

In hill roads, additional care has to be taken for ecological considerations, such as:

1. Stability against geological disturbances
2. Land degradation and soil erosion
3. Destruction and denudation of forest
4. Interruption an disturbance to drainage system
5. Aesthetic considerations
6. Siltation of water resources.

### 2.6.3 FORMATION OF HILL ROADS:

The main aim of planning a hill road is to establish the shortest, most economical and safe route between the obligatory points and to achieve this purpose successfully, the following basic principles are to be observed in the planning of hill roads:

1. Construction work
2. Existing routes
3. Intensity of traffic
4. Master plan
5. Natural climatic conditions
6. Use of contours.

#### 2.6.3.1 HILL ROAD CROSS SECTION:

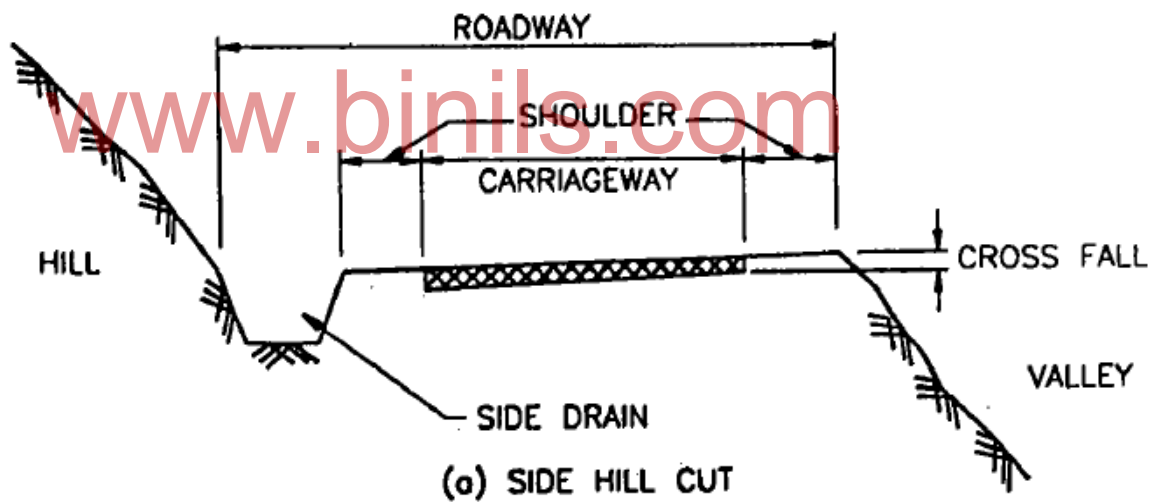

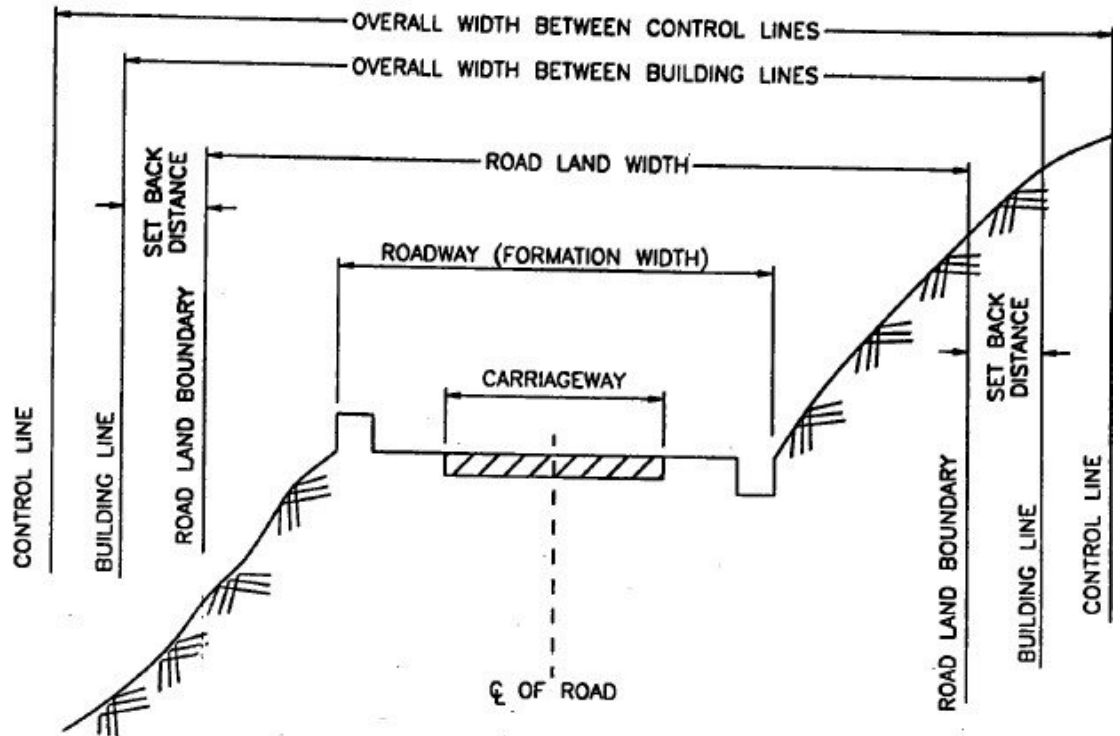

Fig. 2.6.3.1 Cross section of Hill road

### 2.6.3.2 DRAINAGE IN HILL ROADS

The rain falls very heavily on the hills and as the slopes of hills are quite steep, the water reaches the roadside very quickly and creates the drainage problems. The water thus collected should be disposed off in a proper way through well-planned and designed drainage system.

- (1) **Sub-surface drainage:** The seepage flow of water on hills creates problems during and after monsoons. The level of seepage water may be at, above or below the road level depending upon several factors such as depth of hard stratum and its inclination, quantity of underground flow of water, etc. The seepage flow also causes the weakening of the road bed and the pavement and it also causes the problems of slope stability. It is therefore necessary to control the seepage flow by adopting suitable method of subsurface drainage system.
- (2) **Surface drainage:** For carrying the surface water, the side drains are provided only on the hill side of the road, as shown in fig. 10-5. There is limitation in the formation width of road and hence, these drains are constructed of such a shape that the vehicles could utilize the space of side drains in case of an emergency for crossing or parking.
  - (i) provision of catch water drain or intercepting ditch above the side drain; and

(ii) suitable cross-drainage work to divert the water through the road on downside of the hill.

The water from the hill slope is intercepted and diverted through the catch water drains which are running parallel to the roadway. The catch water drains are usually provided with a gradient of 1 in 50 to 1 in 33 to avoid high water velocity and possible wash out. The water from the catch water drains is led to the cross-drainage works through the sloping drains.

The cross-drainage works are in the form of culverts, scuppers or causeways. They are constructed under the road and usually at right angle to it. For collecting the stones and debris and for preventing scour, the catch pits may be provided at the head of small cross drains. The floor level of catch pit may be kept about 300 mm below the sill of culvert

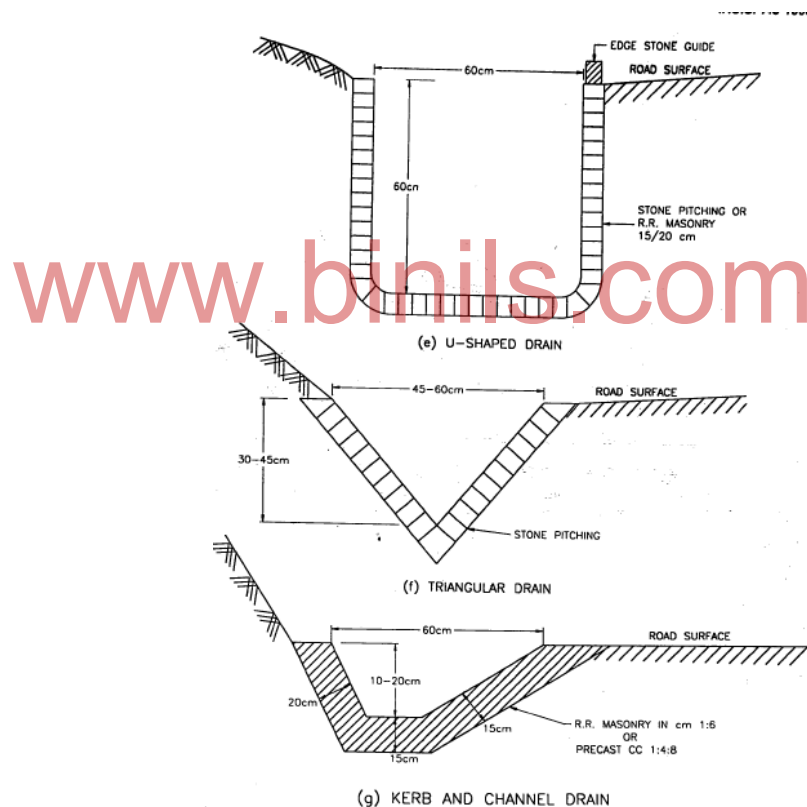

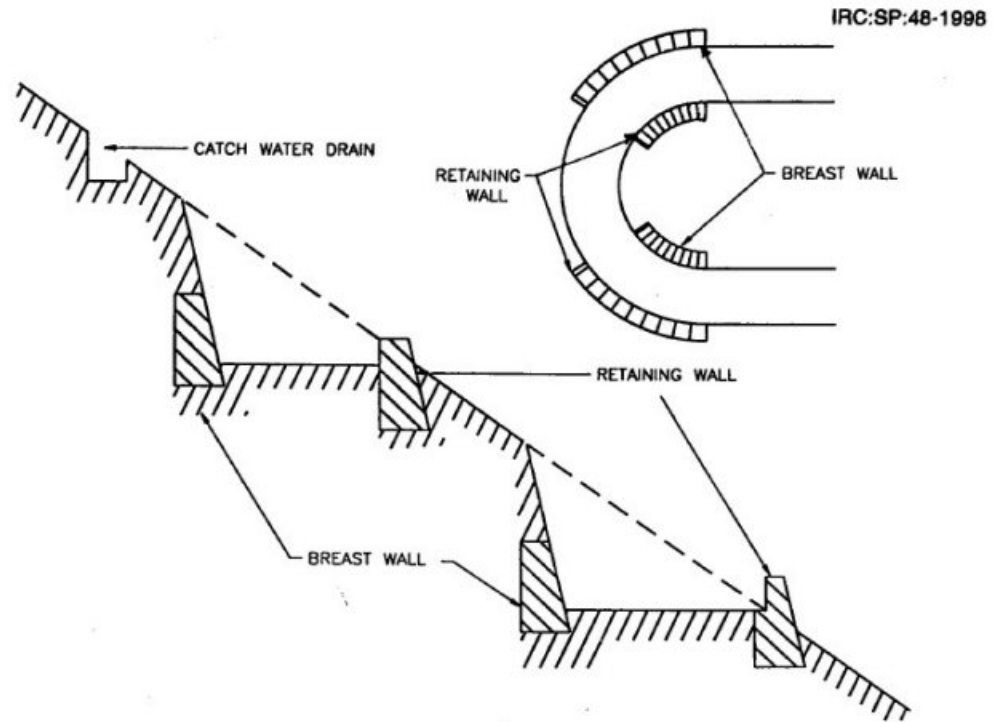

FIG. 7.13. TYPICAL ZIG

#### 2.6.4 ALIGNMENT OF HILL ROADS

The success and utility of a hill or ghat road depends on its alignment. It is necessary to exercise great care fixing the alignment of hill roads. A good alignment has the following features:

- (i) It achieves the minimum costs of construction and maintenance.
- (ii) It allows comfortable travel and the expenditures on motive power as well as wear and tear of vehicles are also greatly reduced.
- (iii) It contains sharp curves having small radius.
- (iv) It gives a stable and safe road.
- (v) It grants the easiest, shortest and most economical line of communication between the obligatory points or important centres to be connected by the hill road.
- (vi) It has the gradient as easy as possible.

In general, it can be stated that the best and most convenient alignment will be the one having the minimum of cutting and filling; and minimum of walling and bridging. In many cases, the alignment of hill road contains two types of sharp curves known as hairpin bends and corner bends. Fig.2.6.4 shows the hairpin bend and the corner bend.

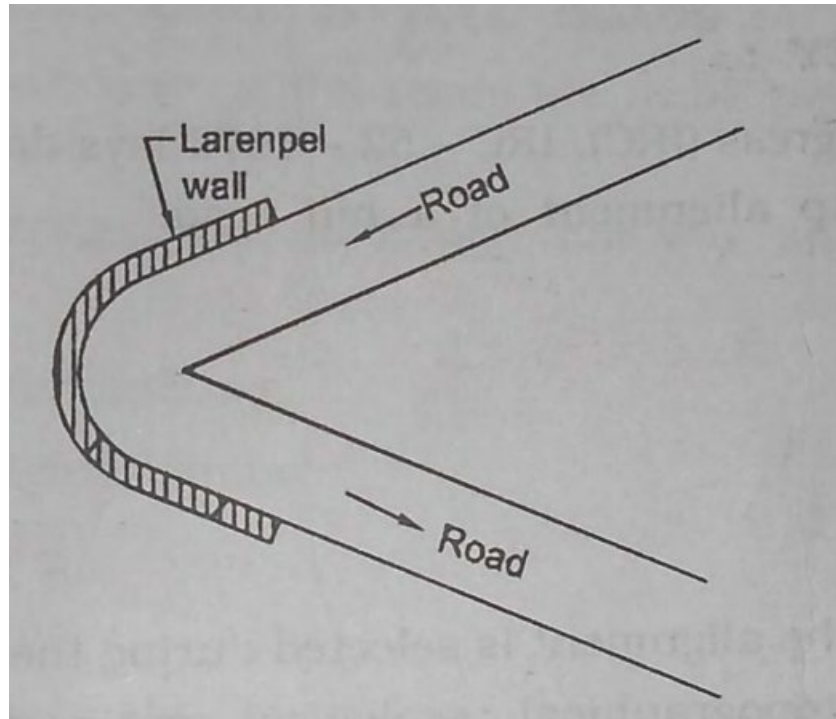

[www.binils.com](http://www.binils.com)







Fig. 2.6.4 Corner Bend and Hair Pin bend

[www.binils.com](http://www.binils.com)

**2.6.5 HAIRPIN BENDS:** A hairpin bend is a sharp curve and it is located on a hill side having the minimum slope and maximum stability. It must also be safe from the view point of land slides and ground water. For reducing the construction problems and expensive protection works, the hairpin bends should be provided with long arms and farther spacing.

### **2.6.6 PROTECTIVE WORKS FOR HILL ROADS**

In order to give stability and a sense of safety to the hill roads, the following three types of protective works are provided:

- (1) Retaining walls
- (2) Breast walls
- (3) Parapet walls.

**(1) Retaining walls:** The formation of a hill road is generally prepared by the excavation of the hill and the material which is excavated is dumped or stacked along the cut portion. The retaining wall is constructed on the valley side of the roadway to prevent the sliding of back filling as shown in fig. 10-5. Thus the main function of a retaining wall for hill roads is to retain the back filling and it is provided at the following places:

- (i) at all re-entrant curves;
- (ii) at places where the hill section is partly in cutting and partly in embankment; and
- (iii) at places where the road crosses a drainage.

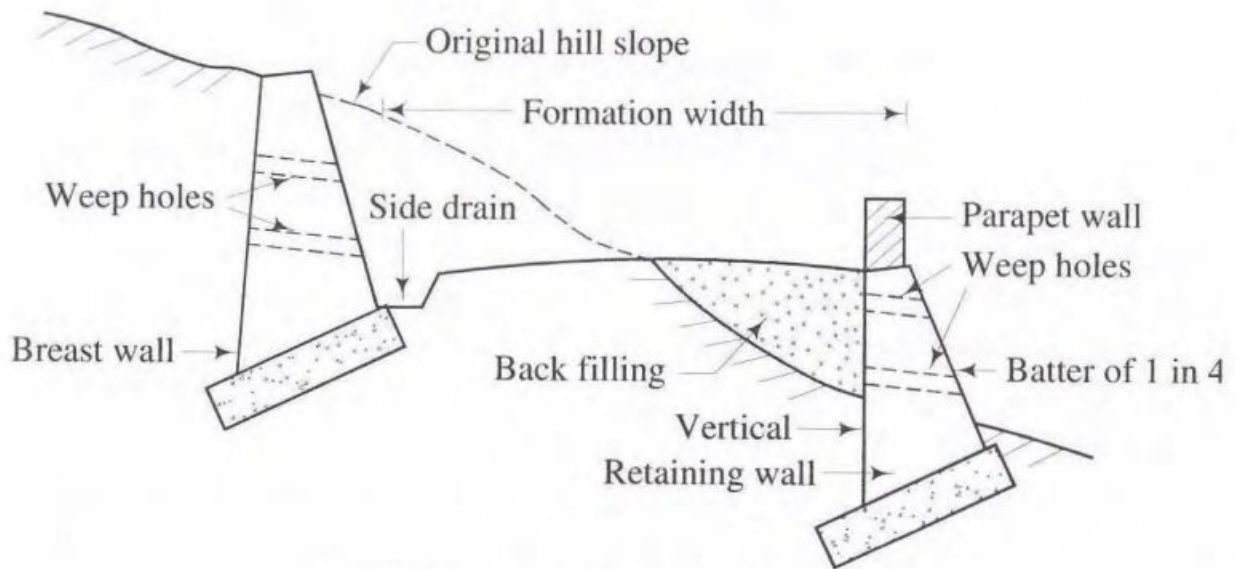

Fig. 2.6.6. Protective works for hill roads

Where stones are economically and easily available, it is customary to construct the retaining walls in dry stone masonry as it permits easy drainage of seeping water. The design of retaining walls is based on rules-of-thumb and the performances of similar existing retaining walls. The minimum width of 600 mm is kept at the top. The rear side is kept vertical. The front side is provided with a batter of 1 in 4. If the height of retaining wall exceeds 6 m or so, the bands of coursed rubble masonry in cement mortar at vertical and horizontal intervals of about 3 m are constructed to grant additional stability to the wall. To facilitate the drainage of the water behind the retaining wall, suitable weep holes at vertical height of 1 m and horizontal spacing of 1.2 m are provided with slope outwards batter or in the form of projections. If the height of the wall is less than 2 m, the entire section is made in random rubble stone masonry. If the height of wall exceeds 2 m, the top portion of 2 m height alone is made in random rubble masonry and the remaining portion is constructed in cement mortar of proportion (1 :6).

The weep holes, as in case of retaining walls, are provided with slope outwards and sometimes, the vertical gutters connecting the weep holes to the side drain are provided.

## UNIT- III

### RAILWAY ENGINEERING

#### Chapter 3.1 INTRODUCTION

##### 3.1.1 Introduction

The history of railways is closely linked with civilization of human beings. As the necessity arose, human beings developed various methods of transporting goods from one place to another. In olden days goods were carried as head loads or in carts drawn by men or animals. Then efforts were made to replace animal power with mechanical power. In 1769, Nicholes Carnot, a Frenchman, carried out the pioneering work of developing steam energy. This work had very limited success and it was only in the year 1804 that Richard Trevithick designed and constructed a steam locomotive. This locomotive, however, could be used for traction on roads only. The credit of perfecting the design goes to George Stephenson, who in 1814 produced the first steam locomotive used for traction in railways.

The first public railway in the world was opened to traffic on 27 September 1825 between Stockton and Darlington in the UK. Simultaneously, other countries in Europe also developed such railway systems; most introduced trains for carriage of passenger traffic during that time. The first railway in Germany was opened from Nurenberg to Furth in 1835. The USA opened its first railway line between Mohawk and Hudson in 1833.

The first railway line in India was opened in 1853. The first train, consisting of one steam engine and four coaches, made its maiden trip on 16 April 1853, when it traversed a 21-mile stretch between Bombay (now Mumbai) and Thane in 1.25 hours. Starting from this humble beginning, Indian Railways has grown today into a giant network consisting of 63,221 route km and connecting our country from the Himalayan foothills in the north to Cape Comorin (Kanyakumari) in the south and from Dibrugarh in the east to Dwarka in the west. Indian Railways has a glorious past of more than 150 years.

##### 3.1.2 Development of Railways in India

In the year 1832 the first Railway running on steam engine, was launched in England. Thereafter on 1st of August, 1849 the Great Indian Peninsular Railways Company was established in India. On 17th of August 1849, a contract was signed between the Great Indian Peninsular Railways Company and East India Company. As a result of the contract an experiment was made by laying a railway track between Bombay and Thane (33.6 Kms).

- On 16th April, 1853, the first train service was started from Bombay to Thane.
- On 15th August, 1854, the 2nd train service commenced between Howrah and Hubli.

- On the 1st July, 1856, the 3rd train service in India and first in South India commenced between Vyasarpadi and Walajah Road and on the same day the section between Vyasarpadi and Royapuram by Madras Railway Company was also opened.

Subsequently construction of this efficient transport system began simultaneously in different parts of the Country. By the end of 19th Century 24752 Kms. of rail track was laid for traffic. At this juncture the power, capital, revenue rested with the British private companies. Revenue started flowing through passenger as well as through goods traffic.

Between the years 1881 and 1897, eight more new private companies were established to bring rapid development in railways.

In the year 1905, Railway Board was established under the Commerce and Industries Department to look after the Indian Railways.

During the World War I (1914 - 1921) some lines of strategic importance were constructed. The nationalisation of Indian Railways took place in the year 1922. Burma was separated from India with its share of 3,200 km length of railway line. During the World War II, 'War Transport Board' was formed and the railway lines were increased to meet the war requirements.

After the Independence of India, most of the private railway companies were taken over by the Government of India. After the partition of India and Pakistan in the year 1947, the length of Indian Railways was reduced from 65,217 km to 54,149 km.

Indian Railways is divided into several zones, which are further sub-divided into divisions. The number of zones in Indian Railways increased from six to eight in 1951, nine in 1952 and sixteen in 2003. Each zonal railway is made up of a certain number of divisions, each having a divisional headquarters. There are a total of sixty-eight divisions. Each of the sixteen zones is headed by a general manager who reports directly to the Railway Board. The zones are further divided into divisions under the control of divisional railway managers (DRM).

<b>Zonal railways details Sl. No</b>	<b>Name</b>	<b>Route km</b>	<b>Headquarters</b>	<b>Divisions</b>
1.	Central	3905	Mumbai	Mumbai, Bhusawal, Pune, Solapur, Nagpur
2.	East Central	3628	Hajipur	Danapur, Dhanbad, Mughalsarai, Samastipur, Sonpur

3.	East Coast	2677	Bhubaneswar	Khurda Road, Sambalpur and Waltair (Visakhapatnam)
4.	Eastern	2414	Kolkata	Howrah, Sealdah, Asansol, Malda
5.	North Central	3151	Allahabad	Allahabad, Agra, Jhansi
6.	North Eastern	3667	Gorakhpur	Izzatnagar, Lucknow, Varanasi
7.	North Western	5459	Jaipur	Jaipur, Ajmer, Bikaner, Jodhpur
8.	Northeast Frontier	3907	Guwahati	Alipurduar, Katihar, Rangia, Lumding, Tinsukia
9.	Northern	6968	Delhi	Delhi, Ambala, Firozpur, Lucknow, Moradabad
10.	South Central	5803	Secunderabad	Vijayawada, Hyderabad, Guntakal, Guntur, Nanded, Secunderabad
11.	South East Central	2447	Bilaspur	Bilaspur, Raipur, Nagpur
12.	South Eastern	2631	Kolkata	Adra, Chakradharpur, Kharagpur, Ranchi
13.	South Western	3177	Hubli	Hubli, Bengaluru, Mysore
14.	Southern	5098	Chennai	Chennai, Trichy, Madurai, Salem, [12] Palakkad, Thiruvananthapuram
15.	West Central	2965	Jabalpur	Jabalpur, Bhopal, Kota
16.	Western	6182	Mumbai	Mumbai central, Ratlam, Ahmedabad, Rajkot, Bhavnagar, Vadodara
17.	Kolkata Metro Railway		Kolkata	Kolkata

The railway system in India is the biggest in Asia and second largest in world under a single management being next to the Soviet Railways.

Indian Railways have a network of 62,000 km, with 34,000 km on broad gauge, 24,000 km on metre gauge and 4,000 km on narrow gauge. There are 7,500 stations of varying capacity.

About 35,000 passenger bogies and 4,00,000 goods bogies are also ply in the track of Indian Railways.

The Indian Railways carry about 80 lakhs of passengers and 7 lakhs tonnes of freight everyday. About 10 lakhs of people are employed in the Indian Railways.

### 3.1.3 Locomotives

In the year 2003–04, Indian Railways owned a fleet of 7817 locomotives including 45 steam locomotives, 4769 diesel locomotives, and 3003 electric locomotives. The number of steam locomotives reached its peak in 1963–64 with 10,810 units. It then declined gradually, as the production of steam locomotives was stopped in 1971. Diesel and electric locomotives,

which are more than twice as powerful as steam locomotives, have progressively replaced steam locomotives. Owing to the heavy investments involved in replacing all the existing steam locomotives with diesel and electric locomotives, steam locomotives were gradually phased out, and it was decided that these should be retained in service till the expiry of their Service life or 2000 AD, whichever is earlier. Accordingly, most steam locomotives of the Indian Railways have been phased out.

Apart from replacing steam locomotives with diesel and electric locomotives in areas of heavy traffic density, a large number of diesel shunting engines are also being introduced as replacements for steam shunting locomotives. This has enabled Indian Railways to improve operational efficiency in both passenger and freight operations.

### 3.1.4 Production Units of Indian Railways

Apart from zonal railways, there are six production units. The details given in the following table.

Unit	Headquarters	Production
Chittranjan Locomotive Works	Chittaranjan	Electric locomotives
Diesel Locomotive Works	Varanasi	Diesel locomotives
Integral Coach Factory	Chennai	Coaches
Diesel Components Works	Patiala	Diesel components
Rail Coach Factory	Kapurthala	Coaches
Wheel and Axle Plant	Bengaluru	Wheels and axles

### 3.1.5 Classification of Indian Railways

The Railway Board has classified the railway lines in India based on the importance of the route, the traffic carried, and the maximum permissible speed on the route. The complete classification is given below

#### ***Broad gauge routes***

All the broad gauge (BG) routes of Indian Railways have been classified into five different groups based on speed criteria as given below.

<b>Group</b>	<b>Sanctioned speed</b>
Group A Lines	160 kmph
Group B Lines	130 kmph
Group C Lines	Suburban sections of Mumbai, Kolkata and Delhi
Group D and D Special Lines*	100 kmph
Group E and E Special Lines*	Other sections and branch lines

\* D Special and E Special routes based on the importance of routes, it has been decided that few selected routes presently falling under D and E routes will be classified as D special and E special routes. This has been done for the purpose of track renewal and priority allotment of funds.

### 3.1.6 Rail Gauges

Gauge of railway track is defined as the clear minimum horizontal distance between the inner top faces of the two rails of a track. (Fig.3.1)

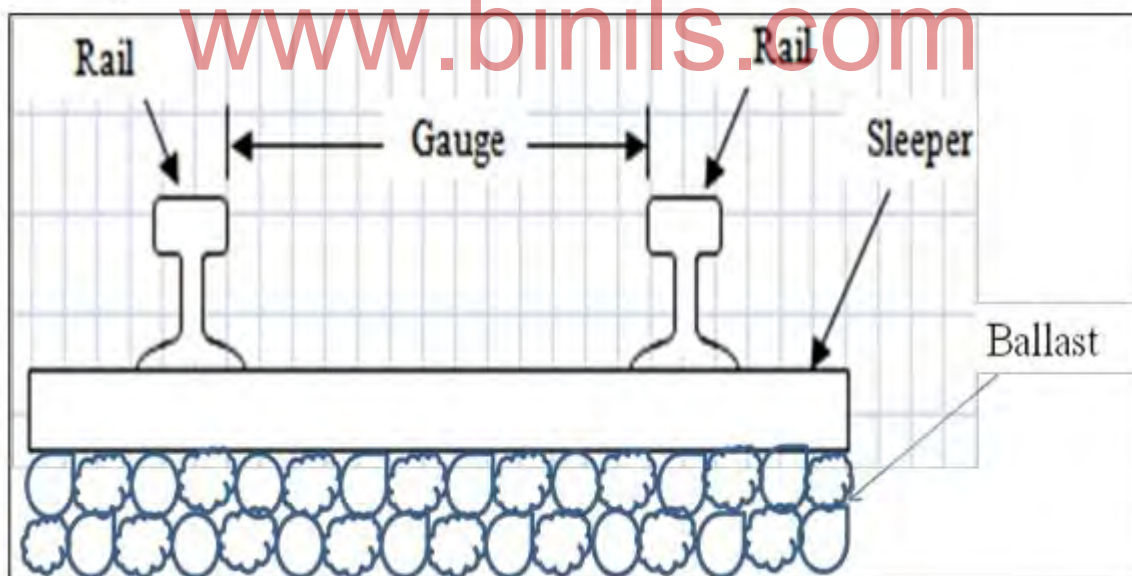

**Fig.3.1 Rail gauge**

#### 3.1.6.1 Types of Rail Gauges

Various gauges on Indian Railways and its coverage are given below.

Name of gauge	Width (mm)	Route (km) *	% of route (km) *
Broad gauge (BG)	1676 (5'6")	55,188	85.6

Metre gauge (MG)	1000 (3'3.37")	6809	10.6
Narrow gauge (NG)	762 (2'6")	2463	3.8
Total all gauges		64,460	100

\*Data as on 31.03.2011

### 1. Broad gauge (BG)

When the clear horizontal distance between the inner faces of two parallel rails forming a track is 1676mm (5'6") the gauge is called Broad Gauge (B.G) This gauge is also known as standard gauge of Indian Railway and is the broadest gauge of the world. For greater the gauge, higher is the speed. Hence for higher speeds, broad gauge is preferred. Also broad gauge is more stable in running and accommodates more passenger/fright capacity and hence the intensity of the traffic is more and it is cheaper.

### 2. Metre gauge (MG)

When the clear horizontal distance between the inner faces of two parallel rails forming a track is 1000mm, the gauge is known as Metre Gauge (M.G). If the intensity of traffic is more, metre gauge is not recommended. This gauge is, therefore, used for tracks in under-developed areas and in interior areas, where traffic intensity is small and prospects for future development are not very bright.

### 3. Narrow gauge (NG)

When the clear horizontal distance between the inner faces of two parallel rails forming a track is either 762mm or 610mm, the gauge is known as Narrow gauge (N.G). This gauge is, therefore, used in hilly and very thinly populated areas.

#### 3.1.7 Uniformity in Gauges

The need for uniformity of gauge has been recognized by all the advanced countries of the world. The ill-effects of change of gauge are numerous. The multi-gauge system is not only costly and cumbersome but also causes serious bottlenecks in the operation of the Railways and hinders the balanced development of the country. Indian Railways therefore took the bold decision in 1992 of getting rid of the multi-gauge system and following the uni-gauge policy of adopting the broad gauge uniformly. The conversion to uni-gauge will result in high initial expenditure, but it will be highly economical over a period of time, considering the following advantages.

(i) No transport bottlenecks

There will be no transport bottlenecks after a uniform gauge is adopted and this will lead to improved operational efficiency resulting in fast movement of goods and passengers.

(ii) No trans-shipment hazards



There will be no hazards of trans-shipment and as such no delays, no damage to goods, no inconvenience to passengers of transfer from one train to another train.

(iii) Provisions of alternate routes

Through a uni-gauge policy, alternate routes will be available for free movement of traffic and there will be less pressure on the existing BG network. This is expected to result in preference to railway rather than road transport in long-haul transportation of passengers and goods.

(iv) Better turnaround : There will be a better turnaround of wagons and locomotives, and their usage will improve the operating ratio of the railway system as a whole. As a result the community will be benefited immensely.

(v) Improved utilization of track

There will be improved utilization of tracks and reduction in the operating expenses of the railway.

(vi) Balanced economic growth

The areas currently served by the MG will receive an additional boost, leading to the removal of regional disparities and balancing economic growth.

(vii) No multiple tracking works

(viii) Better transport infrastructure

Some of the areas served by the MG have the potential of becoming highly industrialized; The uni-gauge policy will help in providing these areas a better transportation infrastructure.

### 3.1.8 Loading Gauge

The loading gauge consists of a vertical post with a horizontal arm, from which a curved frame is suspended. It is constructed at the exit of the goods yard as shown in fig.3.2. Its main function is to confirm that the top of the loaded wagon would clear all the structures such as bridges, tunnels, etc., en-route its destination

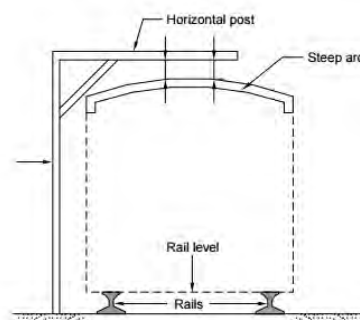

Fig.3.2 Loading gauge

### 3.1.9 Construction Gauges

By adding the necessary clearance to the loading gauge, the construction gauge ensure that vehicles can move safely at the prescribed speed without any obstruction/violation. The various permanent structures on railway lines such as bridges, tunnels, and platform sheds are built in accordance with the construction gauge so that the sides remain clear of the loading gauge.

## CHAPTER 3.2 RAILS

### 3.2.1 General

The finished or completed track of a railway line is known as permanent way. It essentially consists of the following three parts namely, Rails, Sleeper and Ballast, as shown in fig.3.3.

Rails are similar to “I” section girder fixed in two parallel lines to form the track to provide a continuous level surface for the movement of trains.

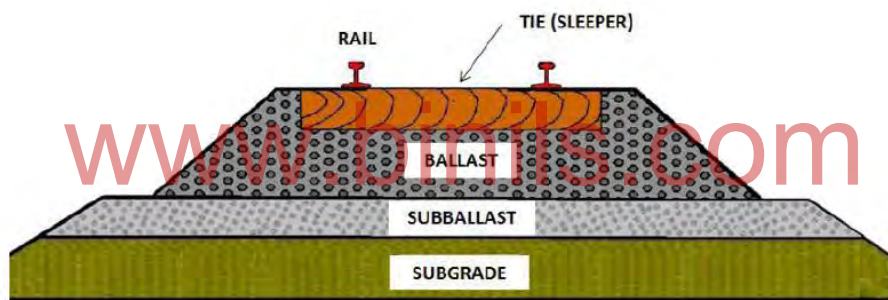

**Fig.3.3 Component parts of railway line**

Two steel rails are fixed parallel on the sleepers by means of suitable fixtures and fastenings and at right angles to them. The sleepers are embedded in ballast which is spread over the formation ground. The rails should be strong and rigid enough to bear the wheel loads and impacts. Generally, they are made of high-carbon steel to withstand stresses.

### 3.2.2 Function of Rails

1. The rails should provide continuous and level surface for the movement of trains.
2. The rails should provide a smooth and uniform surface and should bear the heavy loads transmitted through the wheels.
3. The rails should bear lateral stresses due to braking and thermal stresses as well.
4. The rails should transmit the load to the ballast formations through sleepers.
5. Wear of rails should be the least.

### 3.2.3 Requirements of an Ideal Rail

1. The rail should have the most economical section consistent with strength, stiffness, and durability.
2. The rail shape should be such that fish-plates can easily be fitted.
3. The rail face should resist wear.
4. The rail should possess adequate lateral and vertical stiffness.
5. The rail should be made of proper composition of high-carbon steel.
6. The depth of head of rail should be sufficient to allow for an adequate margin of vertical wear.
7. The centre of gravity of rail section should lie very near to the centre of height of rail.
8. The height of the rail should be adequate for vertical stiffness and strength as a beam
9. The rail section should conform the standards prescribed by the Indian Railways.
10. The head of rail should have adequate height to resist vertical shear.

### 3.2.4 Types of Rail Section

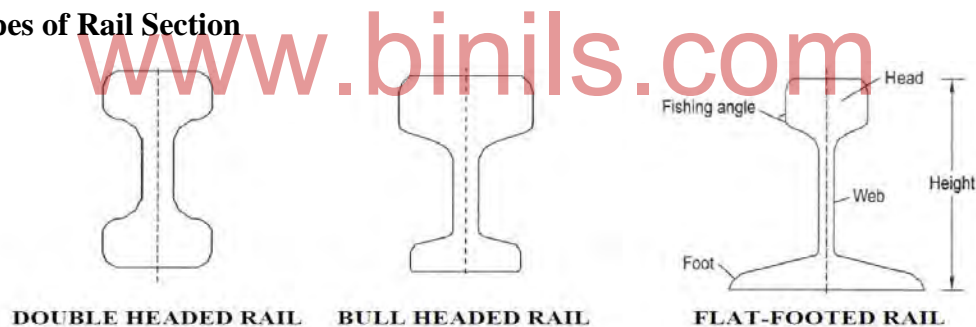

Fig.3.4 Rail sections

Rail sections can be classified into the following types:

1. Double-headed rail
2. Bull-headed rail
3. Flat-footed rail

#### 1. Double-headed rail

The first rails used were double headed and made of an “T” or dumb-bell section. For fixing, each rail requires one chair per sleeper. The advantage of this type of rail was that when the head had worn out, the rail could be inverted and be used, thus economical. In practice, it was found that due to impact, the lower head got dented. The lateral stability was

also very poor and hence, could not be used as head. This led to the development of bull-headed rail.

## **2. Bull-headed rail**

Bull-headed rail is similar in shape to double-headed rail but with more metal added to the head to withstand wear. The foot was just sufficient in size to bear the stress induced in it by the moving loads. The foot of the rails are fastened to chairs by wooden keys. Each rail required one chair per sleeper for fixing. It also had poor lateral rigidity.

## **3. Flat-footed rail**

Flat-footed rail has the shape of inverted “T”(approx.). It is stronger than bull-headed rail. It needs no chair and the foot of the rail may be spiked directly to the sleepers. The main advantage of this type of rail is its lateral rigidity. The heavy train load tends to sink the rail into the sleepers. This causes loosening of the spikes when the flat-footed rails sink directly to the wooden sleepers. To avoid this sinking and for distributing the load on wider areas, steel bearing plates are used between sleepers and rails.

### **3.2.7 Length of Rails**

Theoretically, the longer the rail, the lesser the number of joints and fittings required and the lesser the cost of construction and maintenance. Longer rails are economical and provide smooth and comfortable rides. The length of a rail is, however, restricted due to the following factors.

- (a) Lack of facilities for transport of longer rails, particularly on curves.
- (b) Difficulties in manufacturing very long rails.
- (c) Difficulties in providing bigger expansion joints for long rails.
- (d) Heavy internal thermal stresses in long rails.

Taking the above factors into consideration, Indian Railways has standardized a rail length of 13 m (42 ft) for broad gauge and 12 m (39 ft) for metre and narrow gauge tracks. Indian Railways is also planning to use 26 m, and even longer, rails in its track system.

### **3.2.6 Welding of Rails**

Welding is the process of joining two or more pieces of metal together by heat with or without the application of pressure.

#### **1. Purposes of welding the rails**

In railways the welding process is used for the following purposes.

- a. To join the rails in order to increase their length.

- b. To bring back the worn out and damaged rails, points, crossings, etc. to their original shape and size. Thus increasing their life and reducing the cost of replacement.

## ***2. Advantages of welding of rails***

- a. The welded joints are stronger than any other method of joints.
- b. The welded joints give a smooth working surface and good appearance.
- c. Welding of rails considerably reduces creep.
- d. The welded joints require less frequent inspection and lower maintenance cost.
- e. Welding of rails offer better result in track circuit and electrified tracks.
- f. The risk of sabotage is decreased because it is not possible to undo the welded joints.
- g. The welded rails maintain lateral, longitudinal and vertical stability of the track better.

## ***3. Methods of welding of rails***

There are so many methods of welding in use. The common methods are as follows:

- a. Gas pressure welding
- b. Electric arc welding
- c. Chemical or thermit welding
- d. Flash-butt welding

### **3.2.7 Wear of Rails**

It is the loss of shape of rail heads due to a number of consistent moving wheels on the rails. In course of time, wear and tear occurs on vertical and horizontal planes of a rail head.

Wear occurs due to,

- \* Impact of moving loads
- \* Forces due to rail-wheel interaction
- \* Braking of wheels and
- \* Effects of weather

#### ***1. Types of wear on rails***

The wear can be classified into the following three categories depending upon the position of wear.

- a. Wear on the top of the rail head (vertical wear)
- b. Wear on the ends of the rail (battering of rail ends)
- c. Wear on the sides of the rail head (lateral wear)

#### **a. Wear on the top of the rail head (vertical wear)**

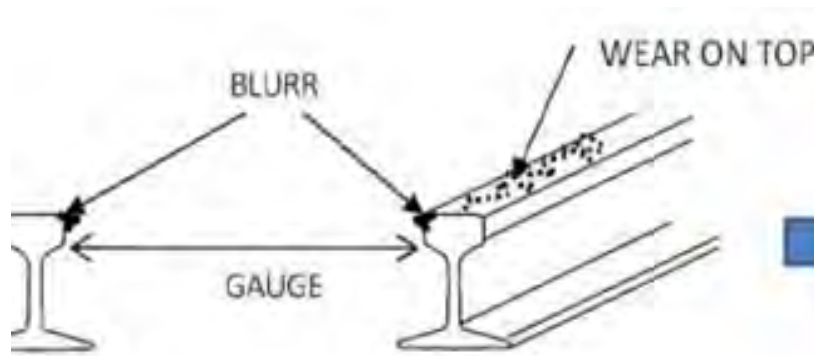

**Fig.3.4 (a) vertical wear**

The metal from the top face of a rail stretches and 'flows' when the stress in the rail exceeds the elastic limits and the rail assumes the shapes as shown in fig.3.4 (a), forming projection beyond the original section of the rail, known as 'blur'.

**Causes of vertical wear of the rail:**

- i. Due to the abrasion of the rolling wheels over the rail.
- ii. The heavy load of a wheel is concentrated in a small area on the inner face of rail which results in building of high stresses in rail exceeding the elastic limit.
- iii. The grinding action of the same particles between wheels and rails.
- iv. Due to corrosion.

**b. Wear on the ends of the rail (battering of rail ends)**

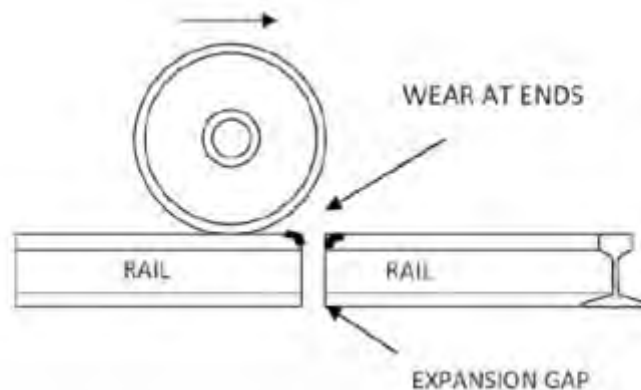
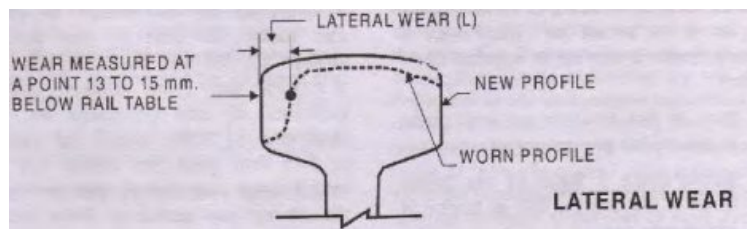

**Fig.3.4 (b) battering of rail ends**

The wear occurs at the end of rails as shown in Fig.3.4 (b) and is much greater than the wear on the top of the rails. This wear is mainly due to the blow which the end of rail receives when a wheel jumps the gap between two rail ends. The rails are battered by such blows.

- i. On curves, the centrifugal force causes thrust of the wheel flanges against the inner side of the outer rail head, which results in the grinding of the rail by the flanges causing side wear.
- ii. On curves, the vehicles do not bend to the shape of the curvature, resulting into biting the inner side of the outer rail head by wheel flanges.
- iii. Wear on inner side of the head of inner rail also occurs due to slipping and skidding of wheels on curves.

**c. Wear on the sides of the rail head (lateral wear)**



**Fig.3.4 (c) lateral wear**

**2. Measures to reduce wear of rails**

Some of the methods adopted to reduce vertical wear and lateral wear on straight paths and curves are listed below.

- a. By reducing the number of joints by welding
- b. By using the bearing plates
- c. By the use of special alloy steel for rails.
- d. By adopting good maintenance of track.
- e. By reducing the expansion gap.
- f. By using proper lubricants.
- g. By adopting inner exchange of inner and outer rails.
- h. By introducing check rails on sharp curves.

**3.2.8 Coning of Wheels**

If the track of the wheels rest flat on the rails, there will be lateral movement of the axle. This results in the damage to the inside faces of the head of the rails. This is prevented by sloping the tread at a slope of 1 in 20. This sloping of the wheels from the vertical axis is known as coning of wheels. (Fig.3.5).

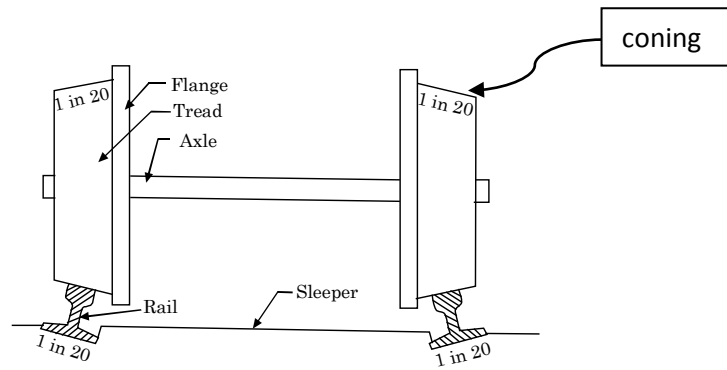

**Fig.3.5 Coning of wheels**

As the wheels and the axle are monolithic, on curves the coning of wheels help the outer wheel to cover a large distance without slipping than the inner wheel, for the same number of revolution. Also, the vehicle is maintained at the centre of its run by coning of wheels.

### 3.2.9 Hogged Rails

Due to the battering action of wheels over the end of rails, the rails get bent down and deflected at ends. The rail with this defect is called hogged rail. Besides, rail ends get hogged due to poor maintenance of the rail joint, yielding formation, loose and faulty fastenings, and other such reasons. Hogging of rails causes the quality of the track to deteriorate. This defect can be remedied by measured shovel packing.

### 3.2.10 Bending of Rails

On curve, the rails should be bent true to the curvature of the curve. In flat curves (less than  $3^\circ$ ) the rails need no bending as they are retained in curved position by the sleepers. The sleepers in turn, are held by the ballast heaped up at their ends and flush with the top of sleepers. The filling up of ballast in this manner is known as boxing. For curves more than  $3^\circ$ , it is desirable to bend the rails to the correct curvature before fastening them to the sleepers. Otherwise, elbows would occur at the joints, as the joints are less flexible in the horizontal direction.

### 3.2.11 Creep of rails

Creep is defined as the longitudinal movement of the rails in a track. Creep is common to all railway tracks, but varies considerably in magnitude.

#### 1. Causes of creep





### Fig.3.6 Wave motion in loaded rail

- a. Development of wave motion in the rails (fig.3.6)
- b. Forces acting at the time of starting accelerating, slowing down or stopping the train.
- c. Unequal expansion and contraction of rails due to temperature variations.
- d. Use of low quality sleepers.
- e. Improper fixing of rails.
- f. Improper maintenance of track.
- g. Uneven spacing of sleepers.
- h. Insufficient ballast.
- i. Inadequate drainage arrangements

### 2. Effects of creep

- a. Dislocation of sleepers affecting the gauge and alignment of track.
- b. Excess opening of rail joints develops considerable stresses in fish plates and bolts, thus rendering their breakages.
- c. In some places at joints, the jamming prevents expansion tending buckling of rails.
- d. Distortion of points and crossings affect the gauge and alignment. The movement of switches made difficult and interlocking is thrown out of gear.

### 3. Methods of correcting creep

The following four methods can be used to correct the creep of rails.

- a. Pulling back of rails
- b. Providing steel sleepers
- c. Providing anchors or anti-creepers
- d. Efficient and proper maintenance of track.

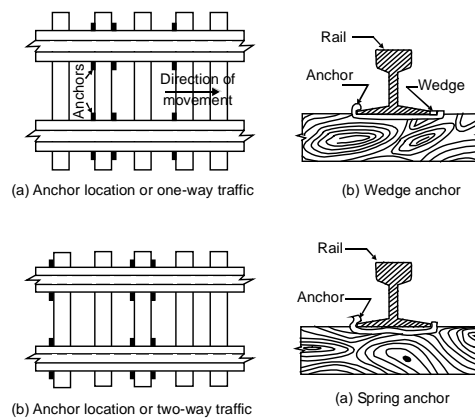

Fig.3.7 Creep of rails -Anchor and location

**a. Pulling back of rails**

When creep has set in, the rails are pulled back to their original positions.

**b. Providing steel sleepers**

Sleepers should be of such type and with such fittings that they prevent the rail from creeping on them. Also, the sleepers must have a good grip in the ballast to resist the movement of the sleeper itself in the ballast. Increase in the number of sleepers will help in the prevention of creep.

**c. Providing anchors or anti-creepers**

These are fastened to the foot of the rail and are in absolute contact with the side of the sleeper on the side opposite to the direction of creep. If creep is taking place in both directions, anti-creepers are provided on both sides of the sleeper (fig.3.7).

**d. Efficient and proper maintenance**

Frequent inspection and proper maintenance of tracks will considerably reduce amount of creep of rails. Use of more amount of clean ballast minimises creep to a very great extent.

[www.binils.com](http://www.binils.com)

## CHAPTER 3.3 SLEEPERS AND BALLAST

### 3.3.1 General

Sleeper is a transverse ties that are laid to support the rails. The main function of sleepers is to support the rails, keep the two rails at correct gauge and distribute the load from the rails to the ballast.



**Fig.3.8 Rail sleepers**

### 3.3.2 Functions of Sleepers

1. To hold the rail to correct gauge.
2. To provide a firm and even support to rails.
3. To distribute the weight from the rails over a sufficient large area of the ballast.
4. To provide stability to the track.
5. To maintain track alignment.
6. To maintain the track at proper grade.
7. To provide insulation for electrified track.
8. To act as an elastic medium between the rails and ballast and to absorb vibrations.

### 3.3.3 Types of Sleepers

Different types of sleepers are used in Indian Railways depending on their availability, suitability, economy and design. The following are the different types of sleepers.

- a. Wooden sleepers
- b. Cast iron sleepers
- c. Steel sleepers
- d. Reinforced concrete sleepers
- e. Pre-stressed concrete sleepers

#### **a. Wooden sleepers**

Sleepers made of wood are called wooden sleepers. Hard wood such as sal, teak, rose wood etc., and soft wood such as chir, deodar, kail etc., are commonly used for this purpose. Wooden sleepers are cheap and ideal.

### b. Cast iron sleepers

Sleepers made of cast iron are called cast iron sleepers. Cast iron sleepers have been used extensively on Indian Railways. Cast iron sleepers are of two types.

- i. Cast iron pot type sleepers
- ii. Cast iron plate type sleepers

#### i. Cast iron pot type sleepers

It is shown in fig.3.10. This type of sleeper consists of two hollow pots of circular or elliptical in shape, placed inverted on the ballast section. The two pots are connected by a tie bar of section  $50 \text{ m} \times 12.5 \text{ mm}$ . Each pot has two holes for ballast packing and inspection.

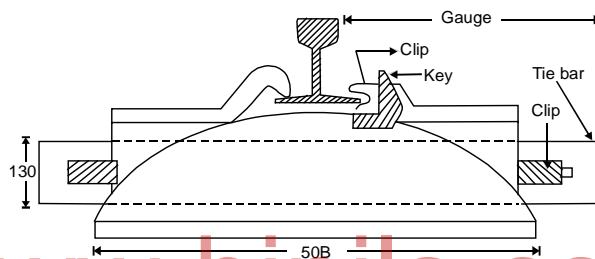

**Fig.3.10 Cast iron pot type sleeper**

#### ii. Cast iron plate type sleepers

This consists of rectangular plates of size about 860 mm, 305 mm with projecting ribs under the plates for their lateral stability. The tie bars can be fixed to the plates by keys, gibs and cotter, distance pieces etc. (Fig.3.11).

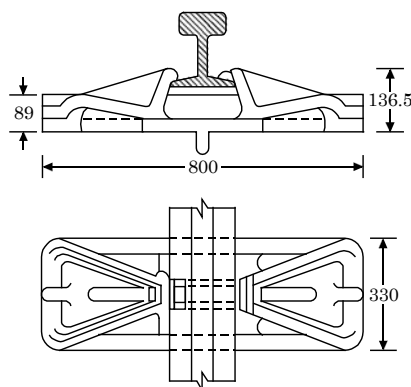

**Fig.3.11 Cast-iron plate sleeper**

### c. Steel sleepers

Sleepers made of steel are called steel sleepers. These sleepers made from 6 mm thick steel sheets, with their both ends bent down to check the running out of ballast (Fig.3.9)

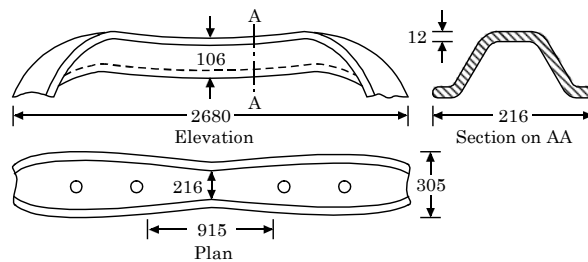

**Fig.3.9 Steel sleeper**

### d. Reinforced concrete sleepers

Sleepers made of reinforced concrete are called R.C. sleepers. There are two types of R.C. sleepers.

- a. A single piece like a wooden sleeper.
- b. Has two R.C. slabs joined together by means of a tie bar generally of a T-section

(Fig.3.12).

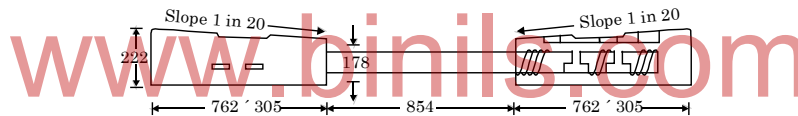

**Fig.3.12 R.C.C. Sleeper - Composite type**

### e. Pre-stressed concrete sleepers

Initially these sleepers are costly but are very cheap in the long run.(Fig.3.13).

There are two types of pre-stressed sleepers.

1. Pre-tensioned sleepers
2. Post-tensioned sleepers

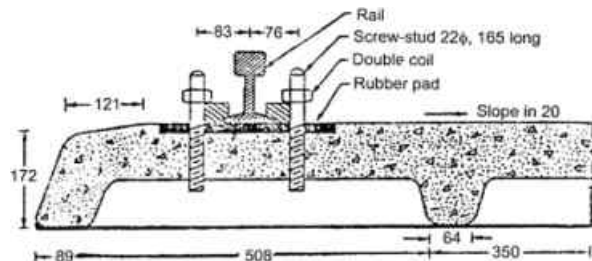

**Fig.3.13 Pre-stressed concrete sleepers**

### 3.3.4 Characteristics of good Sleepers

The requirements of sleepers are listed below.

1. It should be able to maintain proper gauge.
2. It should provide sufficient bearing area for the rail.
3. It should have sufficient weight for stability.
4. It should facilitate the fitting for the easy removal or replacement of rails whenever needed.
5. It should provide adequate area of contact between ballast and rails.
6. It should be elastic, resilient and shock absorbing.
7. It should accommodate the packing of ballasts easily, effectively and quickly.
8. It should not get damaged easily on working.
9. It should facilitate insulation from rails to sleeper if track electrification is required.
10. It should be economical both in initial and maintenance costs.
11. It should not easily be pushed ahead due to passage of trains.
12. It should not easily be damaged or removed any miscreants.
13. It should not be damaged by any insects easily.
14. It should not be affected by weather conditions.
15. It should be repairable or rectifiable.
16. It should not require complicated design in its fastenings.

### 3.3.5 Sleeper Density

Sleeper density is the number of sleepers used per rail on the track. It depends on the speed of train, type and section of rail, type of joints and axle loading. The number of sleepers per rail varies from  $N + 3$  to  $N + 6$  for main tracks where  $N$  is the length of the rail in metres.

### 3.3.6 Ballast

It is a layer of suitable material (stone) used under and around the sleepers in order to distribute the wheel load from the sleepers to the formation facilitating easy drainage of water.

### 3.3.7 Functions of Ballast

The functions of ballast are listed below.

1. To provide a suitable foundation and hold the sleepers in their correct position.
2. To transmit and distribute the load from the sleepers to the formation.
3. To provide an easy means of correcting track levels and increase the elasticity of the track.

4. To protect the surface of formation from direct exposure to the sun, frost or rain.
5. To drain the water immediately and keep the sleepers in dry conditions.
6. To prevent the growth of vegetation inside the track.
7. To resist lateral, longitudinal and vertical displacement of the track.

### 3.3.8 Requirements of Good Ballast

The requirements of good ballast are listed below.

1. It should not be brittle and have sufficient strength to resist crushing under heavy loads of moving trains.
2. It should maintain the shape.
3. It should have sufficient grip over the sleeper.
4. It should be sufficiently durable to resist the abrasion and weathering action.
5. It should be cheap and easily available.
6. It should provide lateral and longitudinal stability of the track.
7. It should easily drain water immediately.
8. It should be easily workable so that it can be easily laid.
9. It should not have any chemical action on rails and metal sleepers.

### 3.3.9 Ballast Materials

The ballast materials are given and explained below.

- |                     |                       |
|---------------------|-----------------------|
| 1. Broken stone     | 2. Gravel             |
| 3. Ashes or cinders | 4. Sand               |
| 5. Kankar           | 6. Murum              |
| 7. Brick bats       | 8. Blast furnace slag |
| 9. Selected earth   |                       |

#### 1. Broken stone

This is the best suitable material for ballast in a railway track. Due to its high interlocking action, it holds the track to the correct alignment and gradient. Granite, quartzite, sandstone and limestone are some of the varieties of stones used for ballast.

#### 2. Gravel

It is obtained from river beds or gravel pits. It is preferable next to stone. It is cheaper than stone ballast. Its drainage property is excellent. It easily rolls down due to rounded shape under vibration and the packing under the sleepers gets loosened. Variation in size is desirable and hence, it requires screening before use.

### **3. Ashes or cinders**

Coal ashes or cinders are available in large quantities on railways from locomotives. They have excellent drainage properties and are the cheapest. But they cannot withstand heavy traffic. They corrode steel and affect the base of the rails.

### **4. Sand**

It forms another reasonably good material for ballast. It has very good drainage property and produces a silent track. It is good for pot sleepers.

### **5. Kankar**

It is lime agglomerate and is found in many places in the form of nodules of varying sizes. It is useful for metre gauge and narrow gauge tracks with light traffic.

### **6. Murum**

Under heavy loads it crumbles to powder. Hence it is used for unimportant lines and sidings.

### **7. Brick bats**

Where no stone or suitable substitute is available, over-burnt bricks, broken into small sizes are used as ballast. It becomes powder under heavy traffic and makes the track dusty.

### **8. Blast furnace slag**

It is a by-product in the manufacture of iron. It forms suitable ballast. It is hard, dense and free from gas holes.

### **9. Selected earth**

It is used for sidings and for newly laid railway tracks.

**(Note:** The ballast materials mentioned in item from 3 to 9 are not common nowadays as the engine and wagon load are very heavy compared to earlier period.)



## CHAPTER 3.4 RAIL FASTENINGS AND PLATE LAYING

### 3.4.1 RAIL JOINTS

A joint is made between two rails to hold them together in the correct position. A rail joint is the weakest part in a railway track. In order to provide provision for expansion and contraction of rails due to variation in temperature certain gap is provided at each joint. This gap causes a break in continuity of rails in horizontal as well as in vertical plane, forming the weakest point of track.

#### Types of Rail Joints

Depending upon the position of joints and sleepers, rail joints may be classified:

1. According to position of joints
2. According to position of sleepers

#### 1. According to position of joints

According to position of joints the rail joints are of the following two types.

- a. Square joints
- b. Staggered joints

#### a. Square joints

When a joint in one rail is exactly opposite to the joint in the other parallel rail, it is called square joint. It is shown in Fig.3.14 (a). It is very common in straight tracks. But at present, staggered joints are more favoured.

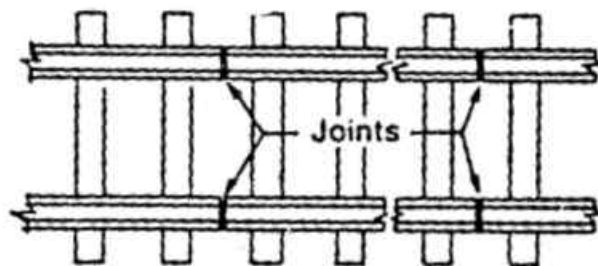

Fig.3.14 (a) Square Rail joints

#### b. Staggered joints

When a joint in one rail is exactly opposite to the centre of the other parallel rail, it is called staggered joints. It is shown in Fig.3.14 (b). In India this type of joint is used on curves.

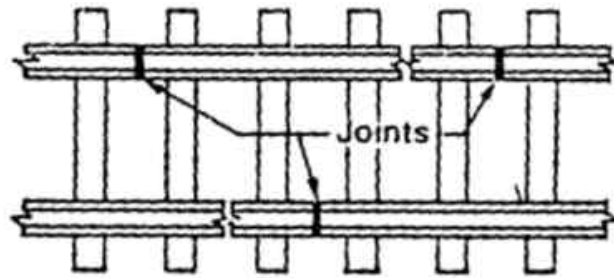

Fig.3.14 (b) Staggered Rail joints

**2. According to position of sleepers**

According to position of sleepers, the rail joints are of the following three types.

- a. Suspended joints
- b. Supported joints
- c. Bridge joints

**a. Suspended joints**

The rail joint that is placed at the centre of two consecutive sleepers is known as suspended joints. It is shown in Fig.3.14 (c). The load is equally distributed on two sleepers. When joint is depressed both rails are pressed down evenly.

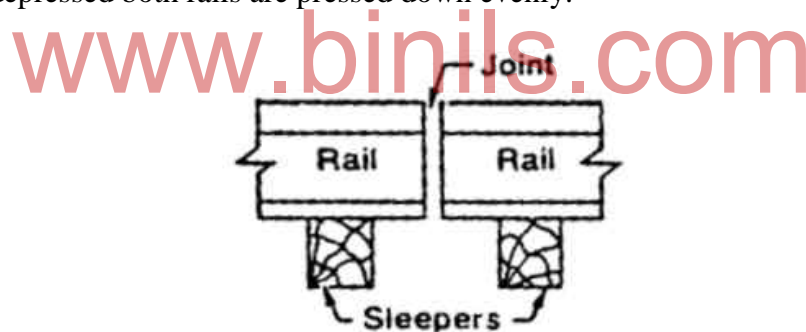

Fig.3.14 (c) Suspended joint

**b. Supported joints**

When the sleeper is placed exactly below the rail joint, it is known as supported joint. It is shown in Fig.3.14 (d). But this does not give sufficient support with heavy axle loads.

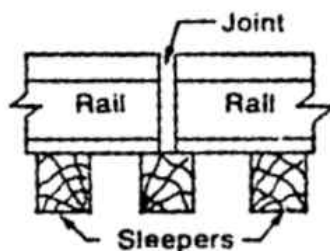

Fig.3.14 (d) Supported joint

### c. Bridge joints

This is similar to the suspended joint, but with a metal serving as a bridge to connect the ends of two rails. It is shown in Fig.3.14 (e). The bridge is placed at the bottom of rails and it rests on two sleepers.

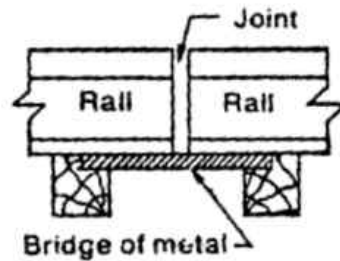

Fig.3.14 (e) Bridge joint

### 3.4.2 Fastenings for Rail

Rail fixtures and fastenings are used to keep the rails in the proper position and to set points and crossings properly. They link the rails endwise and fix the rails either on chairs fixed to sleepers or directly to sleepers. The important fittings commonly used in a permanent way are the following:

1. Fish plates
2. Fish bolts
3. Fang bolts
4. Hook bolts
5. Chairs and keys
6. Bearing plates
7. Blocks
8. Spikes
9. Elastic fastenings

#### 1. Fish plates

Fish plates are used in rail joints to maintain the continuity of the rails and to provide for any expansion or contraction of the rail caused by temperature variation (Fig.3.15).

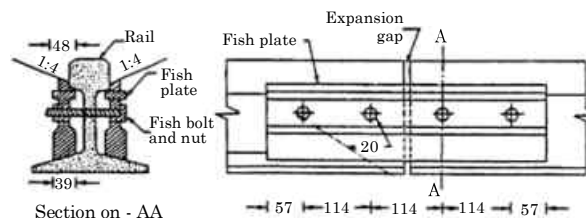

Fig.3.15 Fish plates and bolts

#### Requirement of fish plates

- a. To bear the stresses due to lateral and vertical bending without getting distorted.
- b. To allow for free expansion and contraction of rails.
- c. To resist against wear of rails.

- d. To support the underside of the rail head.

## 2. Fish bolts

The fish bolts have to undergo shear due to heavy transverse stresses. Fish bolts are made of medium or high carbon steel. A bolt of 2.5 cm diameter and 12.7 cm length is used. Generally the length depends on the type of fish plate used. These bolts get loose by the traffic vibration and require tightening from time to time.

## 3. Fang bolts

Fang bolts are employed for fastening slide chairs to the sleepers under the switches. These are used in locations where gauge is to be preserved. Fig.3.18 (d) shows a typical fang bolt.

## 4. Hook bolts

The sleepers are fixed to the girders of the bridges using hook bolts. Usually two hook bolts are used for each sleeper.

## 5. Chair and keys

For double-headed and bull-headed rails, chairs are required to hold them in position. The chairs are invariably made of cast-iron and they help in distributing the load from the rails to the sleepers. All chairs consist of two jaws and a rail seat (Fig.3.16). The keys required to keep the rail in proper position may be of wood or metal. They may be either straight or tapered.

## 6. Bearing Plates

Bearing plates are rectangular plates of mild steel or cast iron. These are used below flat footed rails to distribute the load on a larger area of timber sleepers. (Fig.3.17).

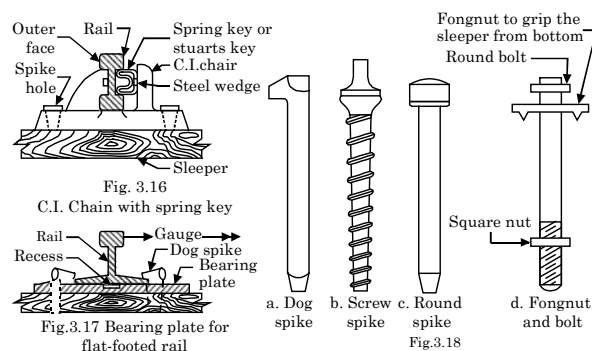

Types of spikes

The advantages of using bearing plates are listed below.

- a. Distribution of wheel load coming on rails to the sleepers over a larger area.

- b. Prevention of damage of the sleepers due to rubbing action.
- c. Holding of spikes firmly to the sleepers.

### **7. Blocks**

When two rails run very close like check rails etc., small blocks are inserted in between the two rails and connected to maintain the required distance. Depending upon the requirements, they may touch either the webs or the fish plates or both.

### **8. Spikes**

For holding the rails to the wooden sleepers, spikes of various types are used (Fig.3.18). These can be used with or without bearing plates below the rails. For holding flat-footed rails to a wooden sleeper, dog spikes are commonly used. Fang nut and bolt is used for fixing slide chairs to sleepers. Round spikes or screw spikes are used as an alternative to fang nut and bolt.

### **9. Elastic fastenings**

In the process of fixing the rail with the sleeper, the fastenings are subjected to severe vertical, lateral and longitudinal forces. In addition, moving loads generate vibration mainly due to geometric irregularities of the track. The old rigid fastening is unable to hold the rail to the sleeper firmly with a constant pressure for a good long time. Thus the track gets affected and there is a need for such a fastening which can safeguard the track parameters and damp the vibrations. For this purpose, an elastic fastening is introduced.

### **3.4.3 ANCHORS AND ANTI-CREEPERS**

To prevent creep in rails, anti-creeper are used. Bearing plates are provided for wooden sleepers. The anchors are of many shapes. A V shaped anchor is found to be very effective to check creep. The following points must be observed for efficient use of anchors.

1. There must be sufficient ballast in the sleeper.
2. The anchors should be uniformly distributed in each panel of rails.
3. Defective anchors should be replaced.
4. Anchors should bear tightness against the sleeper.

### **3.4.4 PLATE LAYING**

The complete operation of laying and assembling of the rails and sleepers of a new track on the prepared formation of railway is termed as plate-laying.

The point upto which the new track has been laid at any time is known as the rail head and the point from where the track laying is commenced is known as the rail base. The progress of day's work is measured by the distance from the base to the rail head.

### **Methods of Plate-Laying**

1. Tram line method or side method
2. Telescopic method
3. American method
4. Plasser Quick Relaying System (PQRS)

### ***1. Tram line method or side method***

This method is useful for plate laying in flat terrain. Also, this method is used when the new track is laid next to the existing track. For plate-laying of new track, either of the following two methods may be adopted.

- a. A service road is constructed parallel to the proposed track and the materials are transported to the site of work.
- b. A temporary rail line is laid, parallel to the proposed track and the materials are transported in wagons. This temporary rail line is known as tram line.

In this method all the required materials are taken from the central depot, in material trains on the existing track and are spread on the formation of new track, After completing the spreading, the work of assembling started from one end manually.

### ***2. Telescopic method***

This method is very widely used in India. In this method, first of all a large central depot is constructed near the junction of the existing railway or highway and the proposed railway line. The manual force is divided as follows.

1. Material gangs
2. Linking-in-gangs
3. Packing-in-gangs.

#### **a. Material gangs**

These gangs unload the materials from the trains. Then they carry the materials to the rail head and supply them to the linking-in-gangs. These gangs distribute sleepers, rails, fish-plates, fish-bolts etc., at required places approximately.

#### **b. Linking-in-gangs**

These gangs mark the centre line of the proposed track and place the sleepers at required places. Then the rails are placed on the sleepers. Successive rails are joined together by fish-plates and bolts after leaving suitable expansion gaps. The expansion gaps are provided equally using shim plates or liner plates. After joining, the rails are fixed to the sleepers.

#### **c. Packing-in-gangs**

After the rails have been fixed to the sleepers by the linking-in-gangs, packing-in-gangs will correct the rails to the required level and gradients by packing earth/ballast below and around the sleepers.

### 3. American method

This method requires special track laying equipment. This is a costlier method and hence not followed in India. In this method, the entire track is assembled in the track laying workshops and the entire unit is lifted up by heavy cranes and placed in position at rail base. The only work which is done at site is the joining of rails by fish-plates and bolts. This method facilitates fast laying of track and enables the throwing of track for service at the shortest duration of time.

### 4. Plasser Quick Relaying System (PQRS)

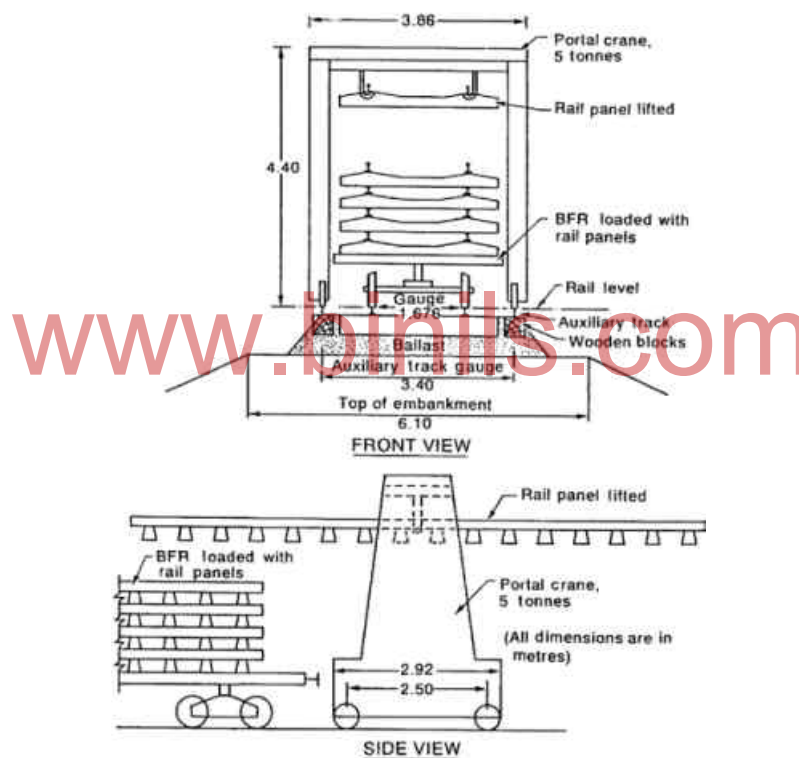

Fig.3.19 PQRS method

Plasser and Theorer Company had introduced Mechanical laying of railway track in Indian Railways. This system of laying track is very popular compare to other system of laying. This method is used for relaying existing track under high traffic condition without interrupting the flow of traffic. But this method requires the use of many tools and machinery and hence comparatively costlier. This method facilitates laying new railway track mechanically.

## CHAPTER 3.5 MAINTENANCE OF TRACK

### 3.5.1 NECESSITY FOR MAINTENANCE OF TRACK

Once the track is opened for traffic, then the necessity of maintenance arises for the following reasons.

1. To increase the life of track and rolling stock.
2. To reduce the operational cost of trains.
3. To have a more safe and comfortable journey.
4. To secure more safety against derailment and accidents.
5. To maintain high speeds of the traffic.
6. To carry the delicate and other good safely.
7. To maintain the level gauge, gradient and cant.

It is therefore necessary to maintain the track in good condition so as to run the trains safely at specified speeds.

### 3.5.2 MAINTENANCE OF TRACK MATERIALS

1. All the worn-out main rails and check rails should be replaced by new ones periodically.
2. The fish-plates and fish-bolts should be oiled periodically to have free longitudinal movement.
3. All the sliding chairs at points and crossing should be oiled for free movement.
4. In the yards, coal-ashes on rails should be removed and cleaned.
5. All the decayed sleeper should be replaced.
6. All the worn-out fish plates should be replaced.
7. All the loose spikes should be corrected.
8. All the worn-out points and crossings should be renewed.
9. If a kink is found in a rail it should be rectified or otherwise replaced.
10. The inner rail on curve with excessive wear should be replaced immediately.
11. In station yards, the rails should be oiled to protect them from corrosion.

#### Tools Required during Maintenance

- |                        |                                 |
|------------------------|---------------------------------|
| 1. Beater-cum-pick axe | - To pack ballast under sleeper |
| 2. Rail gauge          | - To verify the gauge           |
| 3. Cant board          | - To verify cant                |
| 4. Jim crow            | - To bend the rails             |
| 5. Lifting jacks       | - To lift track                 |
| 6. Rail tongs          | - To lift the rails             |



- |                   |  |
|-------------------|--|
| 7. Shovels        | - To handle the ballast                |
| 8. Crowbars       | - To align the track slightly.         |
| 9. Sprit levels   | - To verify cross levels               |
| 10. Adzes         | - To do adzing to wooden sleepers.     |
| 11. Claw bar      | - To take out dog-spikes from sleepers |
| 12. Sleeper tongs | - To lift sleepers.                    |

### **3.5.3 MAINTENANCE OF BRIDGES**

Bridge inspection along the railway track is carried out by track inspectors and bridge inspectors. Track inspectors look after culverts and small bridges. Bridge inspectors look after major bridges. Bridge inspectors are responsible for the following works of bridge maintenance.

1. The soundings are to be taken in the river bed to detect the depth of scour near the abutments and piers.
2. Suitable pitching is to be provided to the embankments near bridges.
3. Flood training bunds will have to be constructed and maintained in case of some river turbulent in nature.
4. The superstructure of girder bridges should be painted with red lead once in five years.
5. The rivets should be carefully inspected at regular intervals and all defective rivets should be replaced.
6. The bearings of girders should be coated with oil frequently.
7. The bed blocks should be inspected and necessary repairs carried out.
8. It should be inspected whether the masonry has cracked, deteriorated or washed at the time of flood.

### **3.5.4 MAINTENANCE OF ROLLING STOCK**

The rolling stock includes locomotives, coaches and wagons. The following points are to be observed during their maintenance.

1. Lubrication of all reciprocating parts and bearing should be carried out.
2. Worn out parts from rolling stock should be replaced then and there.
3. The different parts of rolling stock should be cleaned periodically.
4. All axles which have run 3,22,000 km should be replaced.
5. The locomotive boilers have to be carefully maintained.
6. A passenger vehicle used for a specific period should be dismantled and re-assembled.

## **UNIT – IV RAILWAY ENGINEERING**

### **CHAPTER 4.1 STATIONS AND YARDS**

#### **4.1.1 STATION**

A station is defined as any place on a railway line where traffic is booked and dealt with and where the trains are given an authority to proceed forward.

#### **4.1.2 PURPOSE OF A RAILWAY STATION**

A railway station function to

1. provide facility for waiting and booking of passengers and goods.
2. control train movements.
3. provide passing tracks for trains coming in opposite directions and to allow faster trains to overtake slower trains.
4. supply water, coal, diesel etc., to the locomotives.
5. sort out passenger coaches and goods wagon.
6. add or detach bogies in the trains as per requirements.
7. serve as relief centre for passengers in case of accidents.
8. provide facility for changing locomotives and operating staff.
9. facilitate for repairing engines and changing their direction etc.,

#### **4.1.3 TYPES OF STATIONS**

The stations can be classified on the basis of their functional utility as,

1. Wayside stations
2. Junction stations
3. Terminal stations

## 1. Wayside stations

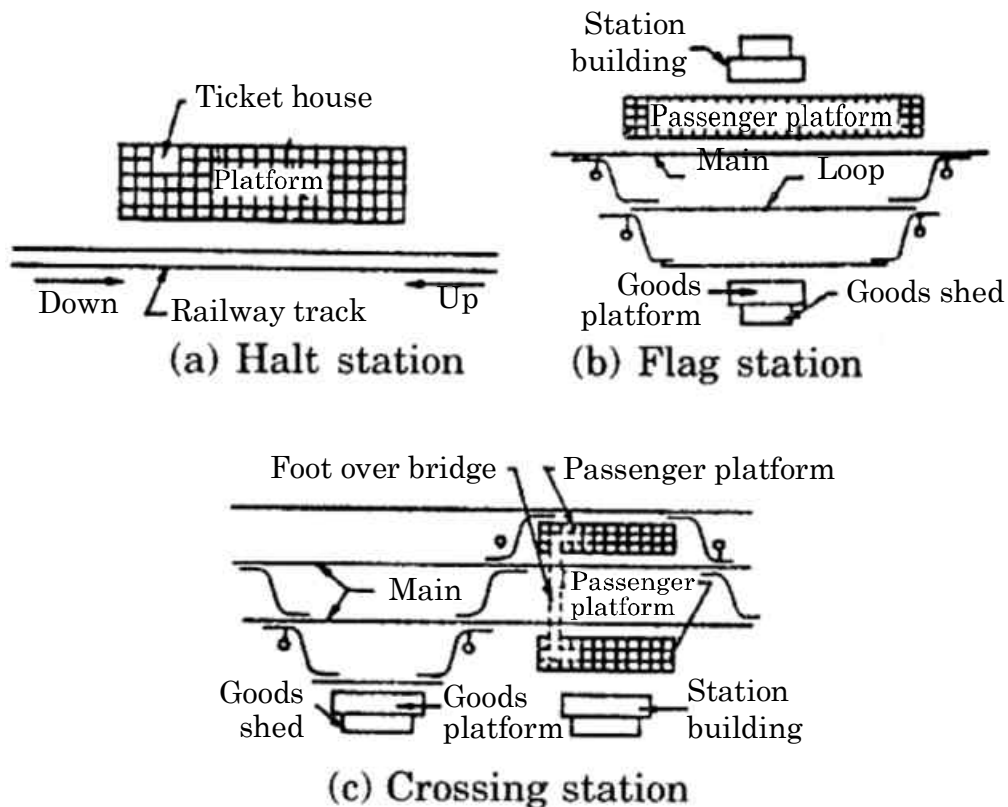

Fig.4.1 Wayside stations (Layout)

In this type of stations, arrangement is made for crossing or for overtaking trains. Wayside stations are of the following types.

- Halt station
- Flag stations
- Crossing stations

### a. Halt stations

These are the simplest types of stopping places. They may or may not have a building or staff. Halts have usually only one platform with a name board on either side as shown in Fig.4.1 (a). At Halts, some trains stop to entrain or detrain passengers. No permanent staff is kept at halts for the issue of tickets. Tickets to passengers are issued either by travelling ticket examiner or travelling booking clerk. Halt stations are usually provided on light traffic sections. The main disadvantage of halts is that many passengers travel without tickets.

### b. Flag stations

The stations where only traffic is dealt with are known as flag stations. These stations have no overtaking or crossing facilities and arrangements to control the movement of trains

(Fig.4.1 (b)). These stations have buildings, staff and communication facilities. Some of the flag stations have sidings also in the form of loops.

### c. Crossing stations

These stations are provided with facilities for crossing. In this type of stations, at least one loop line is provided to allow another train to cross, if one track is already occupied by a waiting train. Generally, the train which has to be stopped is taken on loop line and the other through train is allowed to pass on the main line fig.4.1 (c) shows a typical layout of a crossing station with double line.

### 2. Junction stations

The stations where branch lines join a main line are known as junction stations (Fig.4.2)

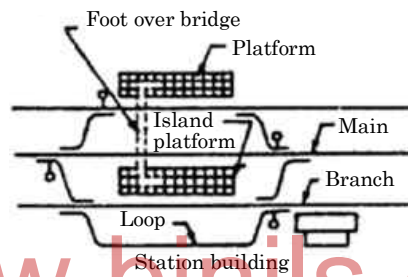

Fig.4.2 Junction station (Layout)

### Arrangements in junction station

- Facilities for the interchange of traffic between main and branch lines.
- Facilities to clean and repair the compartments of the trains which terminate at the Junctions.
- Facilities of good sidings, engine sheds, turn table etc.

### 3. Terminal station

It is a station where a railway line or one of its branches terminates (Fig.4.3).

### Facilities required in a terminal station

- Watering, cleaning, fuelling and servicing the engine.
- Turn table for the change of direction of the engine.
- Yards for dealing goods traffic (such as marshalling yard, engine sheds, sidings etc.)

#### 4.1.4 Platforms

A raised level surface, from where either passengers board and alight from trains or goods loading and unloading is done, is known as a 'platform'. Generally, the following two types of platforms are provided at the stations:

- 1) Passenger platforms, and
- 2) Goods platforms

The length of a platform depends on the longest train running on that section.

##### 1) *Passenger Platforms*

As the name implies, this platform is meant for passengers who are using the railways.

The following are the essentials of a passenger platform:

- i) The platforms should be covered for a minimum distance of 60 m of length.
- ii) A minimum width of 3.66 m of platform should be paved.
- iii) The ends of the raised platforms should be in the form of a ramp with a maximum slope of 1 : 6.
- iv) Adequate arrangement of lighting on platforms should be made for efficient and safe running of trains at night.
- v) Adequate drinking water facilities should be provided and necessary sanitary arrangements be made.
- vi) Names of stations should be written on a R.C.C. board in bold letters. These boards are placed at extremities of the platform and at right angles to the moving train direction. The height of the underside of the board from platform level is generally kept 1.8 m.
- vii) The various dimensions of the passenger platforms are determined on the basis of following:

The station having longest platform in the world exists in India. This platform exists at Sonepur Station on the North-Eastern Railway.

##### 2) *Goods platforms*

As the name implies, these platforms are used for loading and unloading of goods. The following are the essentials of a goods platform:

- i) Goods platforms are generally higher so as to negotiate with high wagon floors. This facilitates in handling of goods.
- ii) Goods shed should be provided on goods platforms and at the same time weighing arrangements should be made on platforms.
- iii) Proper drainage facilities should be provided.

- iv) The facilities for direct access from the goods platforms to the goods sidings and to marshalling yard should be provided.

#### **4.1.5 Station Yards**

A yard is defined as a system of tracks laid out to deal with the passenger as well as goods traffic being handled by the railways. The yard includes receipt and dispatch of trains besides stabling, sorting, marshalling and other such functions. The yards are normally classified as follows.

#### **4.1.6 Types of Yard**

1. Passenger yards
2. Goods yard
3. Marshalling yards
4. Locomotive yards

##### ***1. Passenger yards***

The function of the passenger yard is to provide all the facilities for the safe movement of passengers. The railway platform is the simplest form of the passenger yard.

##### **Facilities in a passenger yard are:**

- i. Booking office, enquiry office, luggage booking room, clock room and waiting room for passengers.
- ii. Parking space for vehicles.
- iii. Signals for reception and despatch of trains.
- iv. Platforms and sidings for shunting facilities.
- v. Facilities of changing batteries.
- vi. Facilities for passing a through-train at speed without interface.
- vii. Washing lines, sick-lines etc.

##### ***2. Goods yard***

A goods yard has to cater for the receipt, loading, unloading and delivery of goods and the movement of goods vehicles. In all the stations, goods yards are provided except in the flag stations.

##### **Requirements of a good yard**

- i. Approach roads for the movement of goods.
- ii. Loop lines with number of parallel dead end sidings, buffer stops etc.
- iii. Sufficient number of platforms for loading and unloading.
- iv. Sufficient number of go downs for storing goods.
- v. Cart-weighing machine.
- vi. Cranes for loading and unloading very heavy goods.

- vii. Booking office.
- viii. Vacuum testing machine

### **3. Marshalling yards**

A marshalling yard is a place where goods wagons received from different centres are sorted out and placed in the order of detachment at different stations.

Marshalling yards are also serving as distributing centres. Empty wagons are also kept in marshalling yards and despatched to different stations as and when required by them

Based on the availability of space and facilities for handling of goods, the marshalling yard are classified as :

- a. Flat yards
- b. Gravity yards
- c. Hump yards

### **4. Locomotive yards**

These are required for servicing like cleaning, fuelling, filling water, oiling, turning round, carrying out small repairs etc. of locomotives. These are installed at junction stations.

#### **Requirements of a locomotive yard**

- i. Sufficient number of tracks for loading.
- ii. Nearness to the passenger and goods yard.
- iii. Water columns.
- iv. Hydraulic jacks.
- v. Sick siding
- vi. Overhead tank and loco-well
- vii. Reserve space for future expansion.

#### **4.1.7 Level Crossings**

When a railway line and a road meet at the same level, it is called level crossing. The surface of the road is kept at rail level and grooves are left along the track in the road surface to receive the flanges of the train wheels. These grooves are provided with guard rails which are generally spiked to wooden sleepers.

The type of facilities provided at level crossing depends upon its classification which in turn depends upon the following three factors.

1. Nature of the road
2. Nature of the traffic on road
3. Number of trains passing over the level crossing.

## CHAPTER 4.2 STATION EQUIPMENTS

### 4.2.1 General

For efficient running of trains, safety of traffic, repairing, cleaning and examining of locomotive, facilities such as equipment and machinery are needed. This equipment and machinery is known as station equipment. Station machinery includes all arrangements and equipment required to carry out for the following:

1. Engine sheds, ash pits, examination pits, drop pits, ash pan etc., are needed for repairing, cleaning and examination of locomotives.
2. Weigh bridges are needed for weighing, loading and unloading of goods cranes.
3. Water columns, triangle or turn - table, traverser etc., are provided for watering, fuelling and reversing the direction of engines.
4. Platform, overhead bridge or underground passage, waiting room, toilets etc., are needed for passengers' convenience at stations.
5. Scotch block, buffer stop, sand hump are provided for arresting the escaped engines and wagons.

### 4.2.2 Engine Sheds

Engine sheds are provided for cleaning, repairing and examining of locomotives and to keep them in perfect condition. In engine sheds water columns, hydrants, examination pit, ash pit, office accommodation etc., should be provided. The types of engine sheds are,

1. Rectangular shed
2. Circular shed

### 4.2.3 Ash-pits (Fig.4.5)

Ash pits are required to receive ashes from locomotive boilers. The ash-pits consist of rectangular masonry lined pits. The depth of the pit is about 0.76 m to 1.22 m and its length is kept slightly more than the longest engine likely to use the ash-pits. The ash-pits are surrounded by longitudinal beams, made either of timber, concrete or steel on which the track-rails are fixed. Timber beams if used should be protected by means of steel-sheets from heating effect of ashes. The ashes collected in ash-pits should be disposed off quickly. The concrete floors of pits are sloped to centre or to one side to form a drain. Water is removed from the pit through a sump and drain.



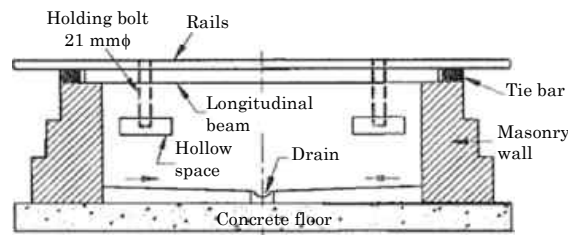

**Fig.4.5 Sectional elevation of ash-pit or Examination-pit**

#### 4.2.4 Examination pits

Examination pits are similar to ash-pits in construction. But these pits are used to examine the engines from underneath. The examination-pits are generally longer than ash-pits. They are provided in the engine sheds to inspect the engine mechanism from below.

#### 4.2.5 Drop-pits

The drop-pits are meant to remove the wheels of an engine by lowering the wheels in the pit for the purpose of examination, repairs or renewals. The pit is constructed at right angles to the track and a mobile hydraulic jack is installed to enable the wheels and axles to be removed.

#### 4.2.6 Water columns

Water and coal are chief requirements for the steam locomotives. Therefore, in all important stations, water columns are provided for feeding water to the boiler (Fig.4.6). In some of the stations, two or more water columns may be provided depending upon the importance of the station. They should be situated in such a way that no obstruction is caused to the traffic. They obtain water from overhead tanks.

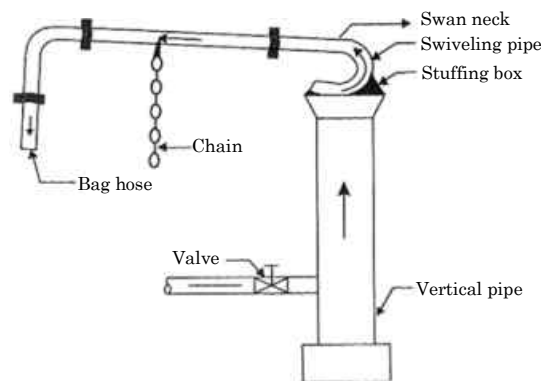
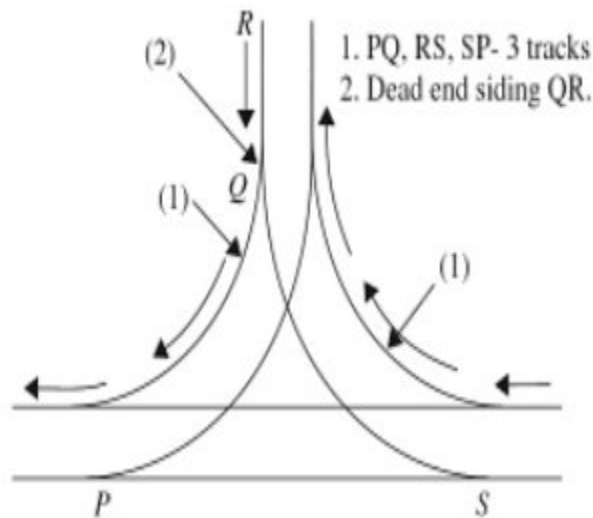

**Fig.4.6 Water column**

A water column is usually composed of a vertical 4.42m high column and a 2.55m long horizontal arm called swan neck, connected to the vertical column at top (Fig 4.6). The horizontal arm can be moved in horizontal plane around the vertical pipe. To regulate the water supply in the water column, a valve is provided. From the water column, water is carried through hose pipes to the locomotives. Generally, water columns are situated near the

entry and exit of the station. To supply for both the parallel tracks, they are installed between them.

#### 4.2.7 Triangle



**Fig.4.7 Triangle**

This consists of three sides of short length tracks in the form of a triangle (Fig.4.7). Such triangles are used for changing the direction of engines. They require large area and generally, a triangle is provided if enough land is available. The tracks of the triangle are connected to each other by means of three pairs of points and crossings. Generally, two tracks are laid in curves and the third straight. Sometimes all three tracks are laid in curves. If the engine is made to move around the triangle, its direction automatically will change.

#### 4.2.8 Turn Table

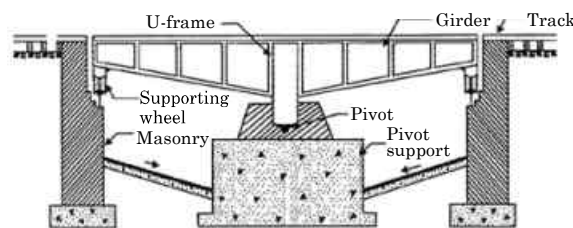

**Fig.4.8 Turn table**

On important stations where space is not adequate for providing triangle for reversing the direction of the locomotive, turn tables are provided (Fig.4.8). It consists of a track on a platform. This platform is supported on a pair of girders. The girders are properly placed and are supported on a central pivot. This circular platform of a turn table is installed in a circular pit. Two or more tracks radiate from the circular edge of the pit. These radiating tracks and

the track on the turn table are kept at the same level. Locking-bolts are provided for controlling the movement of turn table.

A turn table is liable to corrosion due to the presence of water and steam from engines and needs periodical painting. The circle or race rail has also to be kept in perfect level.

#### 4.2.9 Traversers

This is a device for transferring vehicles from one track to a parallel one without the use of a turnout or a crossover. It is a costly arrangement and is preferred only in workshops where space is limited and a coach or locomotive is required to be shifted from one shop to another on a nominated line.

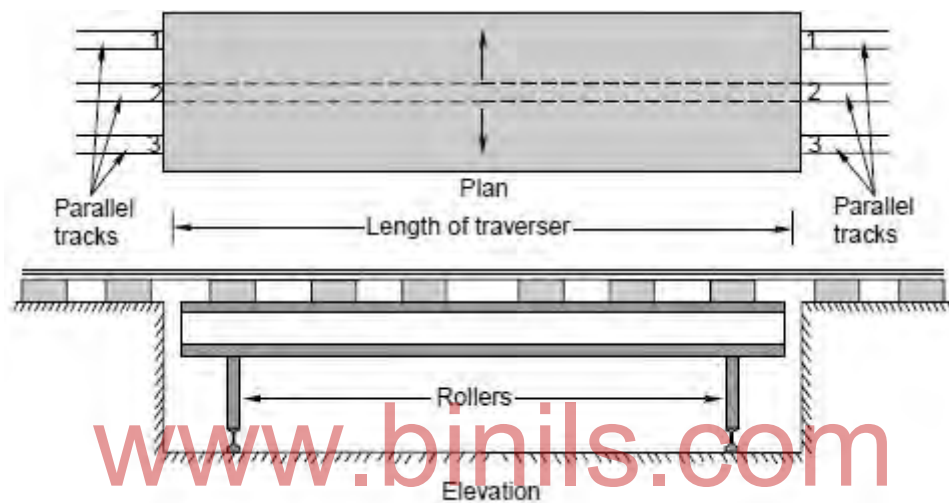

**Fig. 4.9 Traverser**

A traverser (Fig. 4.9) consists of a platform with a track that is mounted on small wheels or rollers, which can traverse to and fro and can fall in line with the track on either side of the traverser. The following steps are involved in transferring a vehicle standing on track 3 on the left-hand side of the traverser to track 2 on the right-hand side.

1. The traverser is aligned with track 3 on the left-hand side.
2. The vehicle is then transferred to the traverser track.
3. The traverser is then shifted so as to align it with the track on the right-hand side.
4. The vehicle is then transferred to track 2 on the right-hand side.

#### 4.2.10 Scotch Block

A scotch block (Fig.4.10) is a wooden block placed on the rail and properly held in its place with the help of a device to form an obstruction. Once it is clamped in position, the scotch block does not allow a vehicle to move beyond it.

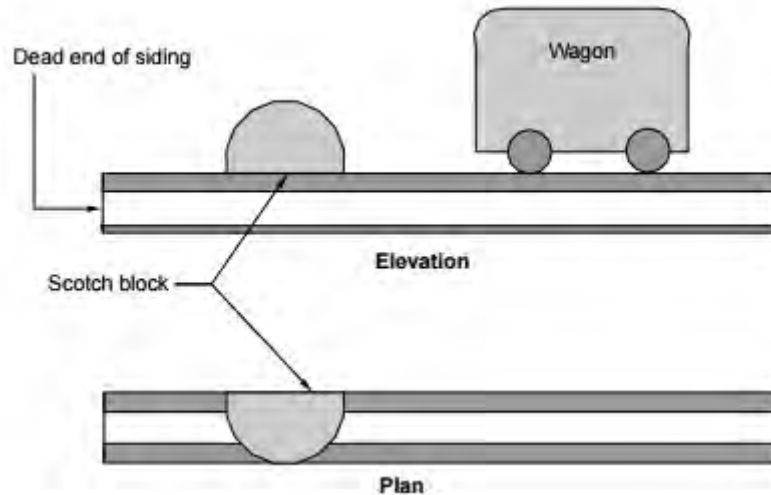

**Fig.4.10 Scotch Block**

#### 4.2.11 Buffer Stops

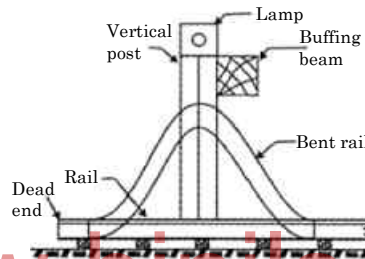

**Fig.4.11 Buffer stop**

Across the track of a siding or at terminal station, a barrier is provided at the end of the track so that the vehicles do not go off the track (Fig.4.11). The 'stop' arrangement is known as a 'Buffer stop'. It should meet the following requirements.

1. It should be visible from a long distance.
2. It should have a buffer disc with a cross sleeper painted red.
3. It should be strong enough to receive the impact of a rolling vehicle.
4. For night indication, it should have a red lamp at the centre.

#### 4.2.12 Fouling Marks

When two tracks converge side collisions are possible between vehicles standing on the turnout portion of the track and those moving over the adjoining track. To guard against this possibility, fouling marks are placed between each pair of tracks where they converge. Fouling marks may be made of unserviceable sleepers, stone or concrete slabs, painted or white washed to make them prominent. They are fixed in the ground at right angles to the tracks, at points between converging tracks beyond which sufficient side clearance is available between wagons. The minimum distance between centres of tracks where fouling

marks are fixed, are 4.2m for broad gauge, 3.75m for metre gauge and 3.6m for narrow gauge. Fig.4.12

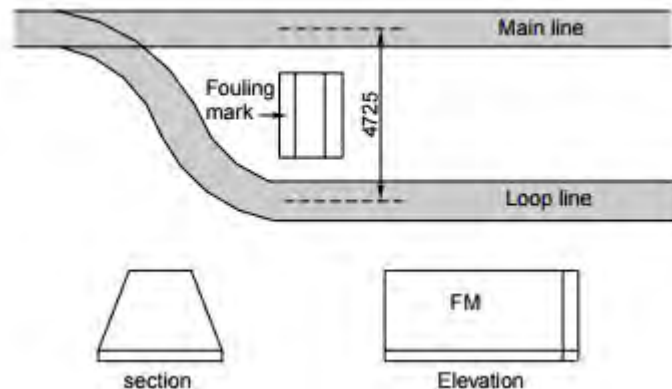
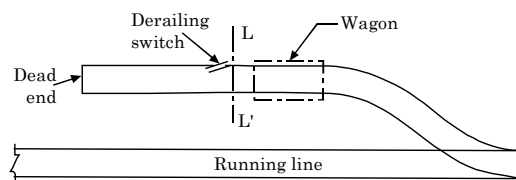

**Fig.4.12 Fouling Marks**

#### 4.2.13 Derailing switch

The purpose of a derailing switch or trap switch is same as that of a scotch block. This is a modification over old block arrangement and is common in modern practice. Isolation of sidings from main lines is done by means of trap-switches or derailing switches. A derailing switch consists of half a set of switches (i.e. one tongue rail only) which normally remains open. This opening of rail provides a break in the continuity of rail. So if a vehicle wants to escape from the siding, it will derail at derailing switch.

But when a vehicle is to be taken out of the siding, this opening at derailing switch must be closed. The details of derailing switch are shown in fig.4.13.



**Fig.4.13 Derailing switch**

#### 4.2.14 Sand Hump

This is a device for preventing the vehicle from running off the track at the end of the siding. A rising gradient is provided at the dead end of the siding along with a sand hump. On account of the combined resistance of the sand hump and the gradient, the vehicles come to a stop. A buffer stop is provided at the end of the hump.

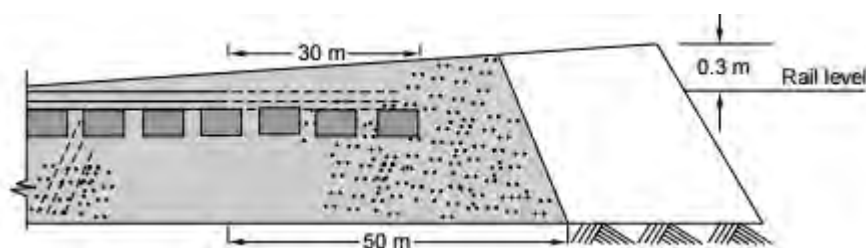

### **Fig 4.14 Sand Hump**

#### **4.2.15 Weigh Bridges**

Weigh bridges are used to weigh the loaded wagons. It consists of a platform supported on beams. The beams are placed below the track level. The wagon is placed on the platform so that the weight of the wagon is indicated by a pointer over a graduated disc. The graduated disc is placed very near the platform on a separate structure. The wagons should be brought on platform carefully with slow speed to avoid damage.

[www.binils.com](http://www.binils.com)

## CHAPTER 4.3 POINTS AND CROSSINGS

### 4.3.1 Purpose of Providing points and Crossings

Points and crossing is the name given to the arrangement which diverts the train from one track to another either parallel to or diverging from the first track. Thus points and crossings are provided to transfer railway vehicles from one track to the other.

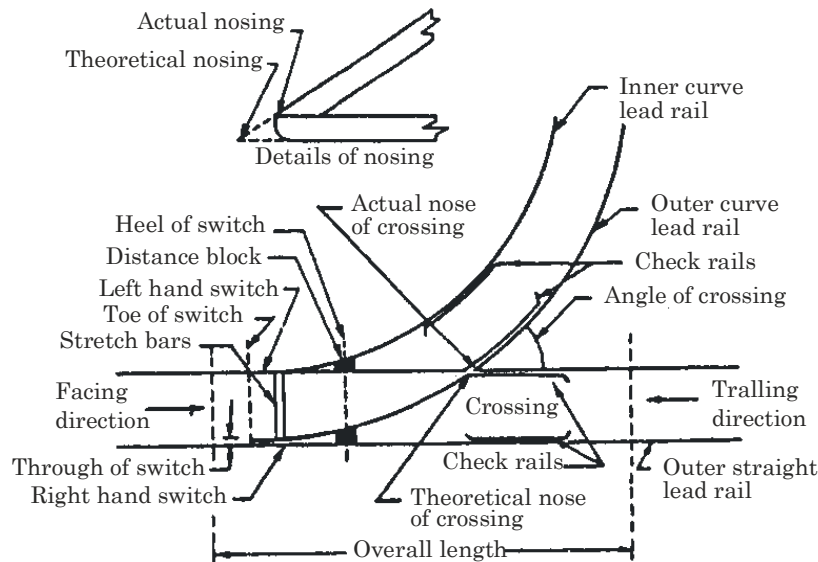

Fig.4.15 Left hand turnout

### 4.3.2 Definitions

#### 1. Switch

It is a device which is used to divert the railway vehicle from one track to another. It consists of a tongue rail and a stock rail. Tongue rails are made of thinner sections to the toe of the switch. Tongue rails are supported on sliding plates and each pair of tongue rail is connected by stretcher bars near the toe of the switch.

#### 2. Throw of switch

It is the distance or gap through which the tongue rail moves laterally at the toe of the switch for movement of trains.

#### 3. Switch angle

It is the angle formed between the gauge face of the stock rail and the tongue rail. It is also known as angle of switch divergence.

### 4.3.3 Turn out

A complete set of points and crossings along with a lead rail is known as a turnout. Depending upon the direction of diverting the train, turnout is known as left hand or right hand turnout.

#### 1. Facing points or Facing turnouts

These are the turnouts where the train first passes over the switches and then over the crossings.

## 2. *Trailing points or Trailing turnouts*

These are the turnouts where the train first passes over the crossings and then over switches. The switches are termed as right hand or left hand switch as seen from the facing direction.

### 4.3.4 Sleepers Laid for Points and Crossings

There are two methods of laying sleepers below the points and crossings.

1. Through sleepers
2. Interlaced sleepers

#### 1. *Through sleepers*

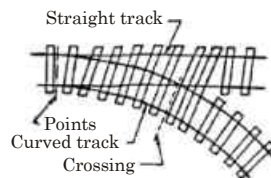

**Fig.4.16 Sleepers for points and crossings - (a) Through sleepers**

Through sleepers are generally laid for points and crossings and they are provided in the overall length of points and crossings (Fig.4.16 (a)).

Through sleepers maintain several rails at the same level especially in straight and curved tracks. But there may be difficulties in the procurement and transporting of longer sleepers.

#### 2. *Interlaced sleepers*

This method of providing sleepers under points and crossings is adopted only when longer sleepers are not available (Fig.4.16 (b)). But as both the tracks are laid on different sleepers, the curved track often deforms and causes difficulties in the maintenance. These sleepers also possess great difficulties in the proper packing of the ballast.

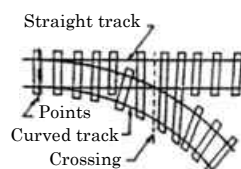

**Fig.4.16 Sleepers for points and crossings - (b) Interlaced sleepers**



### 4.3.5 Types of Switches

#### 1. *Stub switch*

This is the earliest type of switch. No separate tongue rails are provided. But some portion of the main tracks is moved from side to side. It is obsolete now and is no more in use on Indian Railways.

#### 2. *Split switch*

This is the modern type of switch. It consists of a stock rail and a tongue rail. It is further sub-divided into,

- a. Loose heel type
- b. Fixed heel type

#### a. **Loose heel type**

In this type of switch, the tongue rails are joined to the lead rails by means of fish plates. Front two bolts are kept loose to allow the throw of the switch. These bolts become tight when the tongue is open.

#### b. **Fixed heel type**

This type of switch is in common use as it is improved over the loose heel type. All the bolts remain tight when the tongue is closed.

### 4.3.6 Crossing

It is a device provided at the intersection of two rails to allow the train moving along one of the tracks to pass across the other.

#### Types of Crossing

There are four types of crossings,

1. Ordinary or acute crossings
2. Double or obtuse crossing
3. Square crossing
4. Diamond crossing

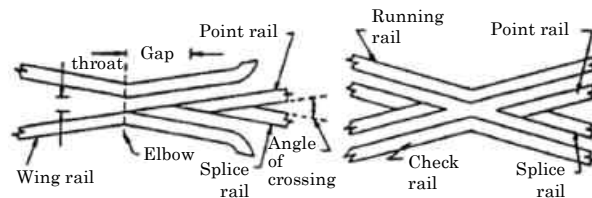

(a) **Acute crossing**

(b) **Obtuse crossing**

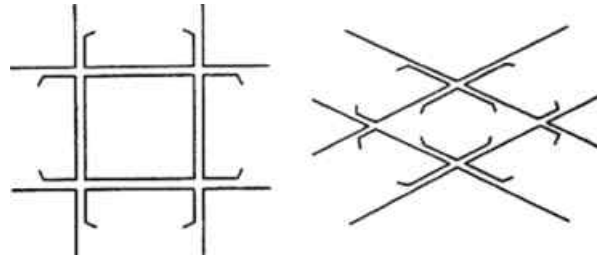

(c) Square crossing (d) Diamond crossing

**Fig.4.17 Types of crossings**

**1. Ordinary or acute crossing**

This crossing is obtained when a right hand rail of one track crosses a left hand rail of another track or vice versa such that the angle formed between the two approaching rail is acute. (Fig.4.17 (a)). It occurs in turnout.

**2. Double or obtuse crossing**

This crossing is obtained when a right hand rail of one track crosses a left hand rail of another track or vice versa forming an obtuse angle between the two approaching. (Fig.4.17 (b)).

**3. Square crossing**

When two straight tracks cross each other at right angles, they give rise to square crossing (fig.4.17 (c)). This type of crossing must be avoided on main lines, because there is a heavy wear due to dynamic loads.

**4. Diamond crossing**

Diamond crossing is the combination of actual and obtuse crossings. In this type, two tracks cross each other completely at an angle, less than  $90^\circ$  (Fig.4.17 (d)) altogether it consists of four crossings.

## CHAPTER 4.4 SIGNALLING

### 4.4.1 Introduction

In fact, in railway terminology signalling is a medium of communication between the station master or the controller sitting in a remote place in the office and the loco pilot. Signalling consists of the systems, devices and means by which trains are operated efficiently, tracks are used to a maximum extent maintaining safety of passengers, staff and the rolling stock. It includes the use and working of signals, points, block instrument and all other equipment.

### 4.4.2 Objects of Signalling

1. To regulate the safe arrival and departure of trains from station yards.
2. To maintain a safe distance between trains running on the same line in the same direction. Thus signalling is used for increasing the capacity of the track and facilitates the flow of traffic with safety.
3. To ensure safe and efficient shunting operations.
4. To ensure safety of cross traffic at level crossings.
5. At any other location where visual indication as to the situation ahead is necessary to be conveyed to engine drivers.
6. To run trains at restricted speeds during maintenance and repair operations.
7. To safe-guard the trains where branch or siding meets the main track.

### 4.4.3 Types of Signals

Signals may be classified based on:

1. Functional characteristics
2. Locational characteristics and
3. Special characteristics

#### 4.4.4 Classification Based on Functional Characteristics

##### 1. Stop signals or semaphore type signals

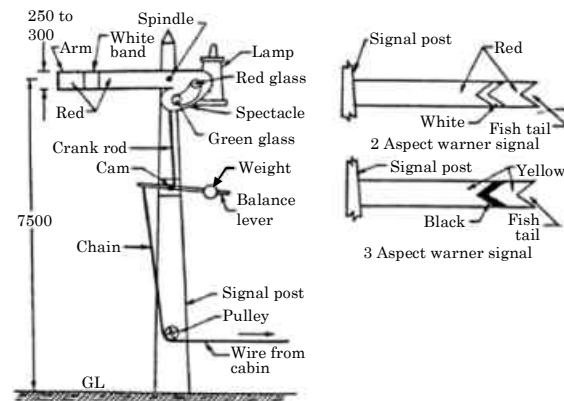

**Fig.4.18 Semaphore and warner signal**

It consists of a movable arm, pivoted-on the horizontal pin known as spindle, near the top of a fixed post (Fig.4.18). The movable arm can take two positions horizontal indicating stop or danger and lowered at an angle of  $45^\circ$  or upright called off position indicating proceed. The corresponding indications at night are red and green respectively.

##### 2. Warner signals

When the horizontal arm of a semaphore signal has a V-shaped notch fish tail at the free end, it is known as warner signal (Fig.4.18). The horizontal arm signifies that the signal beyond it is at danger. When the arm is at an angle of  $45^\circ$  it indicates that the signal ahead is off and the driver may proceed at speed. Warner signals exhibit amber or yellow light, instead of a red light at night when on and in such cases the warner arms are also painted in amber or yellow.

##### 3. Shunting - signals (Disc type)

These are used for regulating shunting of vehicles in yards and therefore known as shunt signals. The disc is circular and painted white with a red band across it. When the red band is in horizontal position or shows red light, it indicates stop. When the red band is inclined at  $45^\circ$  or showing green light indicates proceed. For the light purpose two holes are provided, one for red lamp and other for the green lamp.

##### 4. Coloured light signals

Indications are given by lights, both in day and night. Special lenses and hoods provided enable to throw high intensity beam light. Therefore, these can be seen distinctly even in brightest sunlight. They are used in India or urban or suburban sections with heavy traffic.

#### 4.4.5 Classification based on Locational Characteristics

1. Reception signals
2. Departure signals

##### 1. Reception signals

These control the reception of trains into a station. The reception signals are :

- a. Outer signals and b. Home signals.

##### a. Outer signals

This is the first signal provided indicating the entry of train from block to the station yard. This signal is provided beyond the station limit at such a distance that the line cannot be obstructed after permission to approach has been given. In India, for the maximum allowable speeds, this distance has been found approximately equal to 540m for broad gauge and 400m for metre gauge lines. A certain distance is required for the train in motion to be brought to a halt and this depends on the weight of the train, brake power of the locomotive, gradient at the site and the speed of the train. For the driver, the warning signal gives the indication ahead whether the platform is clear or not.

##### b. Home signals

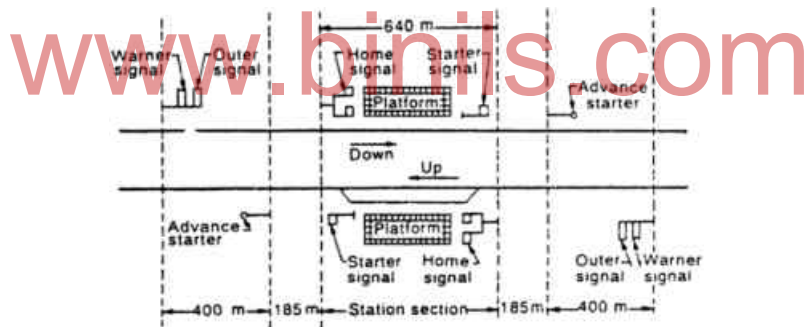

Fig.4.19 Locations of signals

This signal is provided exactly at the station limit and its main function is to protect the stations and junctions. Permission to enter the platform is given by using home signal. The maximum unprotected distance between the home signal and the points is specified as 180m (Fig.4.19). If this distance is more, suitable means such as track circuits, foulding bars etc., should invariably be provided.

##### 2. Departure signals

These control the departure of the trains. These are of two types.

- a. Starter signals
- b. Advanced starter signals

### **a. Starter signals**

The starter signal controls the movement of trains leaving a station. It is normally fixed beyond the farthest point-connection on the line concerned. (Fig.4.19). Separate starting signals are provided for each line.

### **b. Advanced starter signals**

This signal is provided at about 180 metres beyond the trailing points or switches (Fig.4.19). This signal is the last stop signal at the station. If the train leaves the advanced starter signal, the responsibility of the station master is over.

## **4.4.6 Classification Based on Special Characteristics**

Special types of signal are,

1. Repeater or co-acting signals
2. Routing signals
3. Calling-on-signals
4. Point indicators.

### **1. Repeater or co-acting signals**

When the view of the main signal is obstructed due to some structures, on curves etc., some signals are used to repeat the information of the main signals. Such signals are known as repeater signals.

### **2. Routing signals**

When various signals for main and branch lines are fixed on the same vertical post, they are known as routing signals. These are generally provided at big stations. Home signals and routing signals are provided at the points of diversion. Generally signal for main line is kept higher than those for branch lines.

### **3. Calling-on-signals**

These are small arm signals placed below and parallel to home signal on the same vertical post. A calling on signal permits a train to proceed with caution after the train has been brought to a halt by the main signal. These are helpful when repair works are going on.

### **4. Point indicators**

To provide special information to the drivers, indicator is used. These are used to show position of switches. These are generally provided on an open box with white circular discs forming two opposite sides of the box and green bands on the remaining sides.

The white discs indicate that the points are set for the main line. When the points are set for the turnout, the box is rotated on a vertical axis and green bands take the place of the white discs. Night indications are white light for main line setting and green light for the

turnout. The indicator is activated by the turning of the points. Indicators are not treated as signals.

#### **4.4.7 Typical Layout of Signals**

Different layouts may be adopted for various types of signals :

1. Signalling at divergent junction
2. Signalling at convergent junction

##### ***1. Signalling at divergent junction***

The routing signal has been provided near the departing point. Here, only one outer signal is sufficient which may be either semaphore type or warner type.

##### ***2. Signalling at convergent junction***

In this case, outer signals for main and branch lines have been provided separately. In order to avoid collisions, the home signal for the branch line has to be provided at some arbitrary distance, about 400 m away from the fouling point. Fouling point is the minimum safe distance between two converging lines, to avoid side collisions of vehicles.

#### **4.4.8 Control of train Movements**

The safe movements of train on the track are very essential to achieve this objective, various methods have been found out. The methods adopted for control of movement of trains are as follows:

1. Following train or time interval system
2. Absolute block system
3. Automatic signalling
4. Pilot guard system
5. Centralised traffic control system

##### ***1. Following train or Time interval system***

In this method a fixed interval of time is maintained between the departures of consecutive trains. This fixed time is calculated on the basis that sufficient distance must be maintained between the tail of the first train and the head of the next following train. This system is still in use in the case of emergency i.e. failure in telephone or other communication.

##### ***2. Absolute block system***

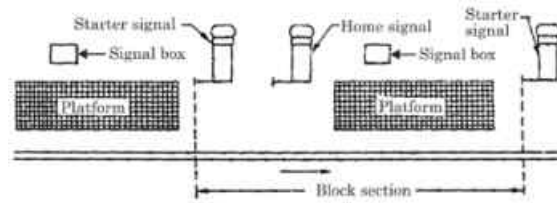

**Fig.4.20 Absolute block system**

In this method instead of a fixed interval of time between successive trains a varying interval may be kept depending on the time actually taken by particular trains.

In the absolute block system the line is assumed to be blocked until the fact that the line is clear, is established by some suitable information conveyed by block instruments.

In the absolute block system, the track is divided into a number of sections which are known as block sections (Fig.4.20). Normally the block section is the distance between two successive stations.

### **3. Automatic signalling**

This system is an improvement on absolute block system and avoids the possibility of accidents due to negligence on the part of human beings. In this system signals are operated by trains themselves and therefore the trains can follow each other between the two stations. The section between the two stations is divided into a number of blocks. When a train occupied a particular track, an electric current is passed through the track and this current puts the signals at danger position till the train reaches a safe distance ahead and requires no further protection in that section. The electric current may be passed in many ways.

Due to automatic signalling, human error is completely eliminated which leads to greater safety and efficiency. Less number of signalmen are required and hence operating costs are reduced. No signal boxes and other equipment are required resulting in further saving of the costs.

### **4. Pilot guard system**

In this system a pilot guard proceeds by one train to the station ahead and then he returns by a train running in the opposite direction. No other train is allowed to move from the station till the pilot guard returns with the train from opposite direction. The pilot guard then again proceeds with a train in the same direction and process is repeated. This system is used only on certain occasions such as:

- a. Break down of telephone and telegraph system on a single line.
- b. One trace of a double line being out of order.



## **5. Centralised Traffic Control system (C.T.C)**

In centralised traffic control system, train movements are effected and the line capacity of a single track is increased to such an extent that it can handle the traffic normally requiring a double track and the necessity of doubling the track can be avoided.

## **CHAPTER 4.5 INTERLOCKING**

### **4.5.1 Definition**

Interlocking is the mechanical relationship established between various levers operating the signals and the points such that contrary effects are not at all possible in the working of the signal mechanism.

### **4.5.2 Principles of Interlocking**

The essential properties of working of interlocking system are as follows:

1. It shall be possible to lower a signal for an approaching train only when the related line is properly set and locked. Once signal is lowered, it shall be impossible to unlock the points.
2. Once signal is lowered for a train in line, it shall be impossible for loose wagons from other point of the yard to obstruct the line.
3. It shall be impossible to any other signal for the admission of trains from opposite directions to the same line at the same time.

### **4.5.3 Methods of Interlocking**

The signals and points are operated by means of levers. Levers are situated at ground level or platform level or in an elevated structure called signal box or signal cabin. Interlocking is done by grouping levers at one point. The levers are painted for easy identification. There are three methods of interlocking.

1. Tappets and locks system
2. Key system
3. Route relay system

#### **1. Tappets and locks system**

This method is useful when levers are to be interlocked so as to prevent conflicting movements. The tappets are of steel sections 38mm × 16mm with suitable recesses and notches. They are attached to the levers. The locks are also of steel with shapes to suit the recesses in the tappets. The lock moves at right angles to tappets.

**Working of tappets and locks system**

The normal setting of the points is for the main line (Fig.4.21 (a)). The signal for the main line should be interlocked with the facing points so that when it is lowered, points cannot be changed. The levers are interlocked such that pulling one of them prevents the other being pulled. This is known as ‘(1) locks (3)’ (Fig.4.16 (b))

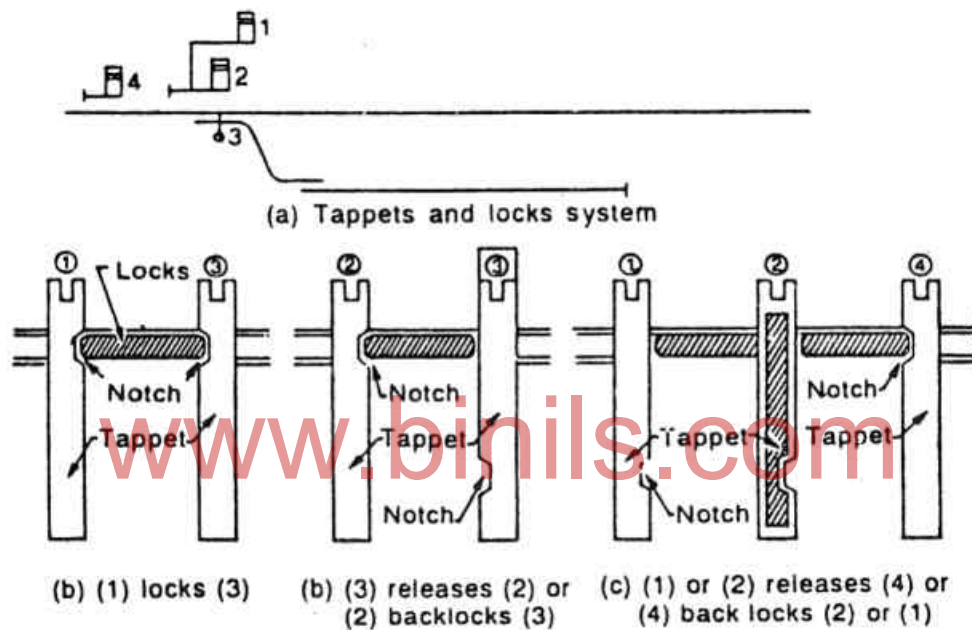

Fig.4.21 Tappets and locks system

The loop signal should be interlocked with the facing points such that it cannot be lowered unless the points are set for the siding. Also it cannot be lowered when the joints are set for main line. Levers (2) and (3) are interlocked so that the lever (2) cannot be pulled unless (3) has already been pulled. Conversely lever (3) can be restored to its normal position only if lever (2) has already been restored to its original position. This is known as ‘(3) release (2)’ or ‘(2) backlocks (3)’. (Fig.4.21 (c)).

The outer signal should be so interlocked with the routing signal that it cannot be lowered until one of them is first lowered. When levers (1), (2) and (4) are interlocked so that lever (4) cannot be worked unless lever (1) or (2) has already been worked. The working of this system is given in the interlocking table below:

Description of levers	Lever No.	Release	locks	Backlocks
Main	1	4	3	-
Loop	2	4	-	3
Points	3	2	1	-
Outer	4	-	-	1, 2

## 2. Key system

This is the simplest method of interlocking. The key locks are manipulated in this system.

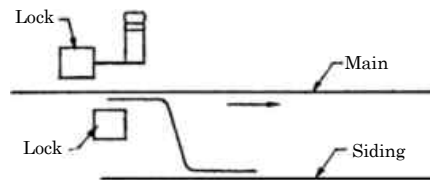

Fig.4.22 Single lock and key system

### Single lock and key system

The principle of this system is to provide two locks which are worked by a single key. Withdrawal of the key locks the signal in the horizontal position, and the points in the normal setting for the main line (Fig.4.22). A and B are two locks operated by a single key. To lower the signal the key is inserted and turned in the lock B. This releases the signal and when the signal is lowered, it prevents the key from being withdrawn. Hence, when the signal is lowered the points are correctly set for the main line. For using the siding, the key withdrawn from the lock B after restoring the signal from normal position and inserted and turned in lock A. This releases the points which may then be set for siding. Now the main signal cannot be lowered.

### 3. Route relay system

In this system, the points and signals for movements of trains are electrically operated. This is the modern and sophisticated system of interlocking. Due to this system there is a considerable saving of man power and maintenance expenditure of cabins.

## CHAPTER 4.6 RAPID TRANSPORT SYSTEM

### 4.6.1 General Railway System

The following four systems of railways are used, suiting to the local conditions, in the urban areas:

1. Surface railways
2. Elevated railways
3. Underground railways
4. Tube railways

### 4.6.2 Underground Railways

This system of railways is provided under the ground level and so it is called "Low-level" or "Under-ground" railways. In the heavily congested urban areas where traffic volumes on roads are heavy, the underground railways going entirely through a sub terrain passage are preferred, as they do not require space on the ground except for entrances and exists, at sub-way stations.

The construction of underground tunnel is required for these railways and an over-bridge is necessary at every road crossing to carry road traffic over railway. Construction and providing ventilation of underground tunnel is complex and costly operation. Due to ventilation problems, electricity is the only suitable source of power for traction that can be used in underground railways.

### 4.6.3 Advantages of Underground Railways

Underground railways offer following advantages:

- i. It provides rapid and unobstructed transportation.
- ii. Helps in reducing traffic congestion problem.
- iii. Provides safety during aerial attack in times of war.
- iv. In busy and extensive metropolitan cities, there is heavy peak-hour traffic particularly in the heart of the commercial and industrial areas. When all the channel of surface transportation gets saturated, it results in heavy detention of traffic due to traffic jams. The road-crossing and junctions further aggravate the problem of detention of traffic. The use of grade-separated crossing can be made at very high cost and that too under certain conditions only. The entire network of roads cannot be reshaped in heavily built up areas. In such problems of transportation, the underground railways provided an ideal solution.
- v. The world experts, on transportation planning, believe that for traffic in congested and heavily built up areas of metropolitan cities, the electrified underground railways are the only solutions of permanent nature.

vi. The loss of time of millions of daily commuters due to detention of traffic, its impact on productivity and efficiency of workers and finally the effect on economic well-being of the community can only be safeguarded by use of underground railways.

vii. The various advances in the techniques and technologies of tunnel driving methods, development in mechanical and power appliances, sub-surface investigations, etc., have solved many of the difficult problems of sub-way tunnels.

viii. The electric traction which is the pre-requisite for the operations of underground railways has already reserved the steam and diesel tractions. Automatic signalling has also been developed on Indian Railways.

In India, the provision of underground systems has already been completed in busy and congested metropolitan areas of Calcutta and Mumbai. This is being gradually introduced in all the important cities of India like Chennai, Delhi, etc to serve the transportation needs of the future.

#### **4.6.4 Tube Railways**

Tube railways are also underground railway but, at a greater depth of about 25 metres or more. The section of underground tunnels carrying the railway is circular like a tube and so they are called "Tube railways". The main purpose of having deep railway tunnels is to avoid the interference of the railway lines with water and gas pipes, sewerage systems, and deep foundations of multi-storey building and oil or drainage pipes etc., which are laid below the ground. Some of the features of the tube railways which are still in a developing stage in index are given below:

- i. The railway stations of the tube railways have to be of cylindrical form.
- ii. Escalators (or moving stair cases) are required to reach tube railways. They are provided for both downward and upward movements.
- iii. Only electric traction is used to avoid the smoke and ventilation problems.
- iv. Automatic signalling through track circuiting is used.
- v. Automatic ticket issuing devices are installed on the platforms so that tickets can be obtained without wastage of time.
- vi. Mechanism of the train is such that it cannot start until all the doors are closed, and it automatically stops, if signal is at "STOP" position.
- vii. Tunnels for tube railways have been constructed to a depth of 25 m below the ground level.

Tube railways are used by London Post Office as transporting mails through a small diameter tunnel with automatic control without any driver.

## UNIT V

### BRIDGE ENGINEERING

#### 5.1 INTRODUCTION

##### 5.1.1 DEFINITION

Bridge is a structure providing passage over an opening such as road, railway, canal, river etc, without disturb the function of opening. The required passage may be meant for road way or railway.

##### 5.1.2 COMPONENTS OF BRIDGE

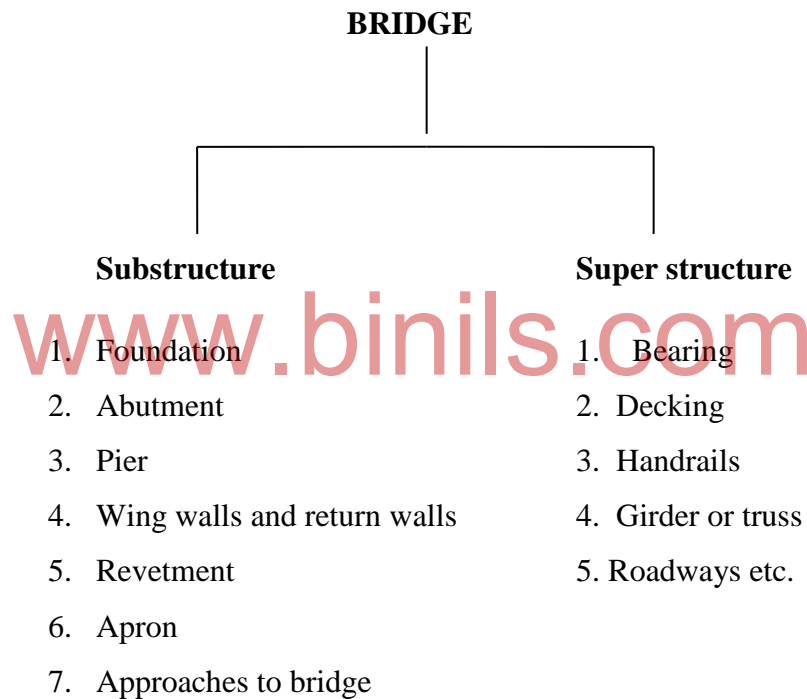

##### **Substructure**

Substructure is the part of the culvert or bridge below the girder bearings and above foundation.

##### **1. Foundation**

It is the lowest part of a structure which provides proper base for the super structure.

## 2. Abutment

End support of a bridge is called as abutment.

## 3. Pier

Intermediate support of a bridge is called as a pier

## 4. Wing walls and return walls

These are masonry walls constructed on the both ends of abutments to retain the embankments and guide the flow of waterway.

## 5. Revetment

It is the sloped structure made of masonry stones laid on both upstream and downstream sides of water way to protect them sliding and erosion due to water.

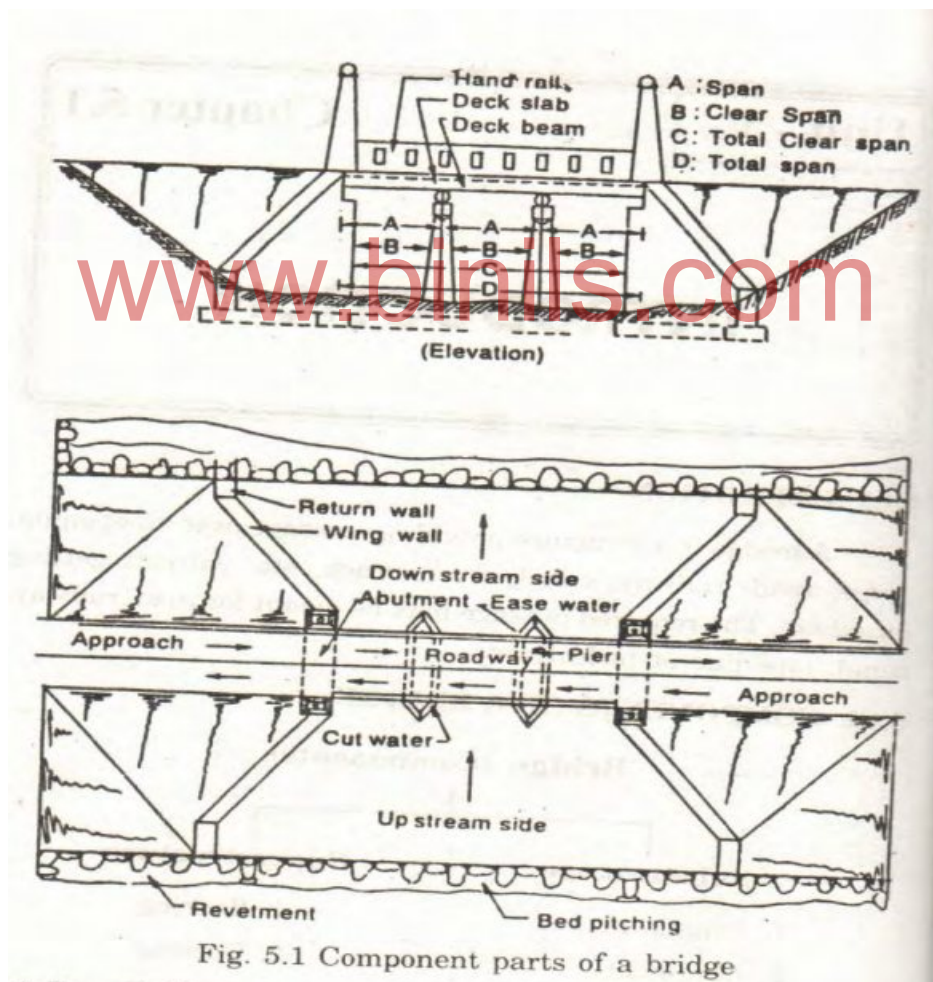

## 6. Apron

It is the bed level flooring made of concrete or masonry stones at the entrance or outlet of bridge in order to prevent scouring.

## 7. Approaches

It is the construction work to join the roadway or railway upto bridge.

### Superstructure

Superstructure is the part of the culvert or bridge above the girder bearings.

#### 1. Bearings

It is the part of a bridge to distribute the load coming from the Superstructure to the substructure and also to allow for longitudinal and angular movements.

#### 2. Decking

It is the part of bridge comprising of the flooring and the supporting beams.

#### 3. Handrails

These are the protective work provided on both sides of the deck along the road in order to safe moving of vehicles and passenger.

#### 4. Girder or truss

It is employed for small bridges where span is less and loads are heavy.

#### 5. Roadway

It means that the pavement or any other flooring for moving vehicle

### 5.1.3 I.R.C. LOADING

The Indian Road Congress (I.R.C.) has classified the loading standards in standards Specification and practice for bridges for live loads as given below:

1. I.R.C. class AA loading
2. I.R.C. class A loading
3. I.R.C. class B loading
4. I.R.C. class 70R loading

#### 1. I.R.C. class AA loading

The I.R.C. class AA loading is based on heavy military vehicles likely to run on certain routes. It is to be adopted for bridges within municipal limits in certain existing industrial areas, certain specified highways such as NH, SH and other important roads where heavy loading is expected. Bridge designed for class AA loading should be checked for class A loading also under certain situations. The maximum bending moment due to class A loading may be greater than that due to class AA loading.



In IRC class AA loading following two types of vehicles are specified.

- a. Tracked vehicle
- b. Wheeled vehicle

**a. Tracked vehicle**

It consists of a packed load of 70t which is equally distributed over two tracks of 850mm width and 3600mm length. The length of vehicle is 7200mm and overall distance between the tracks is 2900mm. The nose to tail spacing between two successive vehicles should not be less than 90m.

**b. Wheeled vehicle**

The maximum load for single axle wheeled vehicle is 20t and for double axel wheeled vehicle is 40t. The axles are spaced not more than 1200mm centers. The maximum wheel load is 6.25t.

**2. IRC class A loading**

The IRC class A loading is based on the heaviest type of commercial vehicle which is considered like to run on Indian roads. Hence, all important road bridges, which are not covered by class AA loading, are to be designed for class A loading. This loading is to be normally adopted on all roads on which permanent bridges and culverts are constructed.

**3. IRC class B loading**

The IRC class B loading is same as class A loading except that 40% less than class A loading. It is to be adopted for the design of temporary structures such as timber bridges etc.

**4. IRC class 70R loading**

This is an additional loading which is sometimes specified for use in place of class AA loading the letter “R” indicates revised classification and it is based on one of the various other hypothetical vehicles as per revised classification . This loading consists of tracked vehicles and wheeled vehicles. The tracked vehicle is similar to IRC class AA loading except the ground contact area. The wheeled vehicle contains seven axles with a total load of 100t.

#### 5.1.4 SELECTION OF TYPE OF BRIDGE

The following preliminary data is essential for select the appropriate type of bridge

1. Length and width of bridge
2. Volume and nature of traffic
3. Nature of river and bed soil
4. Availability of materials and funds
5. Duration of construction
6. Physical feature of the site
7. Availability of skilled and unskilled labor
8. Economic span length of the bridge
9. Hydraulic data such as HFL, LWL
10. Climatic and environmental condition
11. Live load on the bridge
12. Appearance of bridge

#### 5.1.5 SCOUR

It is the removal of bed soil due to high velocity of the stream. Scour will be occurs when the bed velocity of the stream is higher than the limiting velocity.

##### Preventive measures for scour

1. Stream bed will be covered by dumped stones, concrete blocks, or matted vegetation scouring is prevented
2. The river should be pitched with stones to avoid scouring.
3. water way should be adequate so that the velocity does not erode the bed.
4. The site selected for bridge should have uniform stream line flow.
5. The shape of the pier constructed across the stream should not cause eddies and currents in the stream flow.

#### 5.1.6 AFFLUX

Where the flow of water in stream or river meets with any obstruction, the water level will be rises. The difference in levels of the water surfaces between the upstream and the downstream sides of the bridge is called Afflux. The phenomenon occurs only in upstream side of the bridge.

The afflux is greater, the greater velocity in waterway. So, the cost of construction of guide bank and protective works increases.

### **5.1.7 SPAN**

The center to center distance between any two adjacent supports is called the Span and clear distance is called the Clear span.

### **5.1.8 ECONOMIC SPAN**

Economic span is the span for which the costs of super structure and substructure are equal. Thus the economic span of bridge makes the overall cost of the bridge is to be a minimum. It depends on the following factors:

1. Nature of material available for construction
2. Availability of the skilled labor in locality
3. Nature of the water way to be crossed
4. The length of the span
5. The features of the site under which the structure is to be erected.

### **5.1.9 WATERWAY**

The sectional area through which the water flows under a bridge is known as water way. The linear measurement of this area along the length of the bridge at the highest flood level is termed as linear waterway. It is the sum of all clear spans.

### **5.1.10 FACTORS TO BE CONSIDERED FOR SELECTION OF AN IDEAL SITE FOR BRIDGE**

1. On either sides of waterway must be easily communicated between the roads.
2. Straight and well defined embankments both on upstream and downstream sides of the bridge.
3. Availability of men and material easily.
4. Minimum width of water course at crossing.
5. Uniform and steady flow with non silting and non scouring velocities.
6. Good foundations at reasonable depths.
7. Right angled crossing of stream.

8. Waterway should be straight for reasonable length in both upstream and downstream for smooth navigation.
9. Construction should be economical.
10. Maintenance cost should be low.

#### **5.1.11 ALIGNMENT**

To set out the centre line of the bridge is Known as alignment of Bridge.

##### **Factors to be considered in alignment,**

1. The proposed alignment should be economical.
2. Special care should be taken for silting and scouring are not created because of the alignment.
3. The alignment of the bridge should be right angles to the centre line of the river.
4. Skew crossing alignment may be provided depending upon the traffic requirements.
5. As far as possible, the alignment should not be curved. A curved bridge is difficult to construct and maintain.

[www.binils.com](http://www.binils.com)  
**5.2 FOUNDATION**

#### **5.2.1 INTRODUCTION**

It is lowest part of the structure. This provides a firm base for the superstructure, and also it's transmitting all the loads on the structure to the soil properly.

#### **5.2.2 FUNCTIONS OF FOUNDATION**

1. To provide leveled base for construction of sub structures.
2. To prevent unequal settlement of sub soil due to loading from structure.
3. To distribute all the loads from the structures over a large area of the sub soil.
4. Tilting and overturning effects of structures are prevented by maintaining verticality.

#### **5.2.3 TYPES OF FOUNDATION**

1. Ordinary foundation on dry land and rock bed.
2. Foundation in soils saturated with subsoil water.
3. Foundation under water.

## **1. Ordinary foundation on dry land and rock bed.**

- a. Spread foundation
- b. Raft foundation
- c. Grillage foundation
- d. Pile foundation

### **a. Spread foundation**

Spread foundation is to be provided where hard soil is available within 2 to 3 metres below the bed level of the river. Where scouring can be prevented by sheet piling in upstream and downstream and pitching on bed floor, this type of foundation is preferred.

### **b. Raft foundation**

Raft foundation is provided where soil having less bearing capacity. When bed soil contains soft clay and good soil is not available within a reasonable depth (1.5 to 2.5m), this type of foundation is preferred.

### **c. Grillage foundation**

Grillage foundation is used where heavy loads are transmitted to soils of low bearing capacity. It consists of two or more tier of grillage beam spaced at right angles to distribute the load over a large area. Area of the grillage only depends on the bearing capacity of the soil.

### **d. Pile foundation**

Pile foundation is economical under the circumstances of soil at the site of bridge is very soft and good soil is available at a greater depth. And also, loads in foundation are excessive and heavy and all other types of foundation is uneconomical.

## **2. Foundation in soils saturated with subsoil water**

- a. buoyant raft
- b. Invert arch
- c. Pile Foundation

### **3. Foundation under water**

- a. Well foundation.
- b. Caisson foundation
  - i. open caisson foundation
  - ii. Box caisson foundation
  - iii. Pneumatic caisson foundation

#### **a. Well Foundation**

It is used where scouring is liable to occur and good soil is available at nearly 3m below the bed level.

#### **b. Caisson foundation**

It is used, when the depth of water in the river is more and good soil is available near the river bed.

#### **5.2.4 SELECTION OF TYPE OF FOUNDATION**

The following factors to be considered:

1. Nature of sub soil and nature of soil in the bed of stream.
2. Type of bridge
3. Live load in foundation
4. Depth of scour
5. High Flood Level(HFL) of stream
6. Low Water Level (LWL) in the stream
7. Depth of water available at the site.
8. Availability of skilled and unskilled labors.
9. Availability of materials for the construction.
10. Availability of various equipments for construction.

### 5.2.5 CONTROL OF GROUND WATER IN FOUNDATION

Ground water sometimes poses a serious problem during excavation for foundation. If it is not checked, heavy inflow is liable to cause erosion or collapse, the side of excavation. To avoid this problem the ground water movement will be controlled by securing knowledge about the soil and ground water condition with relevant remedial measures.

#### a. Factors involved in ground water control

1. Site investigation is properly done before commencement of the work
2. Quantity of water to be pumped should not be more than the capacity of pump.
3. Should be economical.

#### b. Methods of ground water control

1. Pumping
  - i. Open sumps
  - ii. Well points
  - iii. Bored wells
  - iv. Horizontal wells
2. Electro-osmosis
3. Cement grouting
4. Chemical consolidation
5. Compression air
6. Freezing

### 5.2.6 CAISSON FOUNDATION

It is box type like round or rectangular shape, and it is used to pump the water from foundation at desired depth. It is classified as,

1. Open caissons
2. Box caissons
3. Pneumatic caissons.

#### 1. Open caissons

Open caissons are made of timber, steel or R.C. or masonry with both ends open. It is also called as *well*. Small caissons consist of one opening, while large caissons contain a series of wells. See Fig5.12 (a). This type of caisson is cast and flatted to the site and sunk.

When it reaches the required depth, concrete is deposited through water to some depth. After the concrete gets hardened, the water will be pumped out.

## 2. Box caissons

It is opened at top and closed at bottom. It can be made of steel or R.C or timber. This type of Caissons is built on land, then launched and brought to the site. See Fig5.12 (b) where they have to be sunk. Box caissons can be used with following circumstances:

1. Bearing stratum is available at shallow depth
2. Loads are not heavy
3. For wharfs and breakwaters

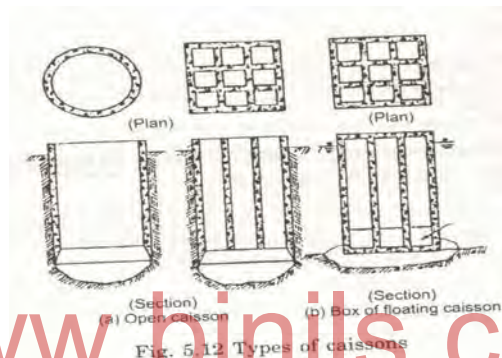

www.binils.com  
Fig. 5.12 Types of caissons

## 3. Pneumatic caissons

A caisson opened at bottom and closed at top in which compressed air is used to keep away the water and mud from trench is called a pneumatic caisson.

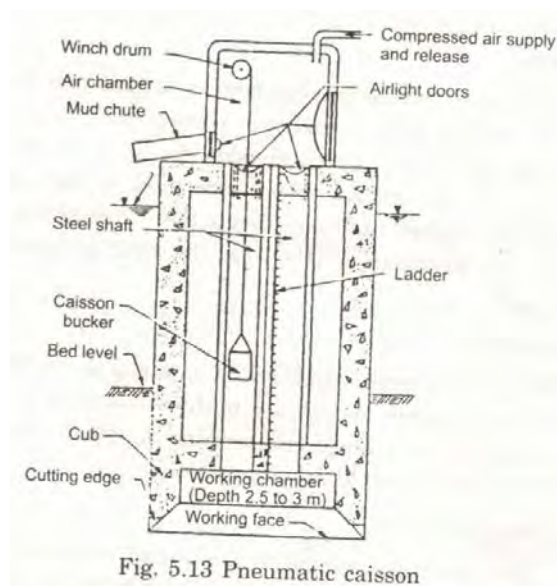

Fig. 5.13 Pneumatic caisson



## **Component parts:**

### **1.Working chamber**

This is air and water tight chamber. There are openings for entrance and exit of men and inlet and outlet of materials through the roof of the chamber. In that the men have to work under high pressure.

### **2.Crip**

It is used to make air and water tight chamber for the caisson. It may be made for R.C. or steel.

### **3.Shafts**

It is vertical tubes of 600mm to 1200mm diameter and made of 3m long flanged steel pipes. One shaft is provided with ladder for workmen's and other side for inlet and outlet of materials and spoils. Both are connected to the airlock at top.

### **4.Airlock**

It is an air tight chamber built on top of the shaft. It has two doors one for atmosphere and another one is working chamber. The lock is to air compressor.

## **Working principles**

It is constructed at the river bank then towed out to the place where it is required at site of the pier, concrete is filled between its double wall and it is sunk into the river bed. When the caisson is sunk on the river bed, compressor air is forced into the working chamber to exclude all the water from the working chamber. Then excavation is started in the river bed and the caisson is allowed to sink. As the caissons sinks the pressure of the compressed air is increased to balance the pressure of water outside , so that it may not enter into the working chamber. When the caisson has reached the desired depth, the bottom is prepared to receive the concrete, and concreting is done through the concrete shaft. A thick layer of concrete is laid and it is acted as a seal. After that air pressure will be released and airlocks and shafts are removed from the caisson. The remaining portion of the caisson is filled with concrete under atmospheric pressure.

### 5.2.7 COFFERDAMS

It is defined as a temporary structure construct to pump out the water and earth from work spot, where foundation is to be laid.

### 5.2.8 TYPES OF COFFER DAMS

1. Cantilever sheet piles
2. Braced coffer dam
3. Earth embankments
4. Double sheet pile wall
5. Cellular coffer dam
6. Rock fill coffer dam
7. bagged earth cofferdam.

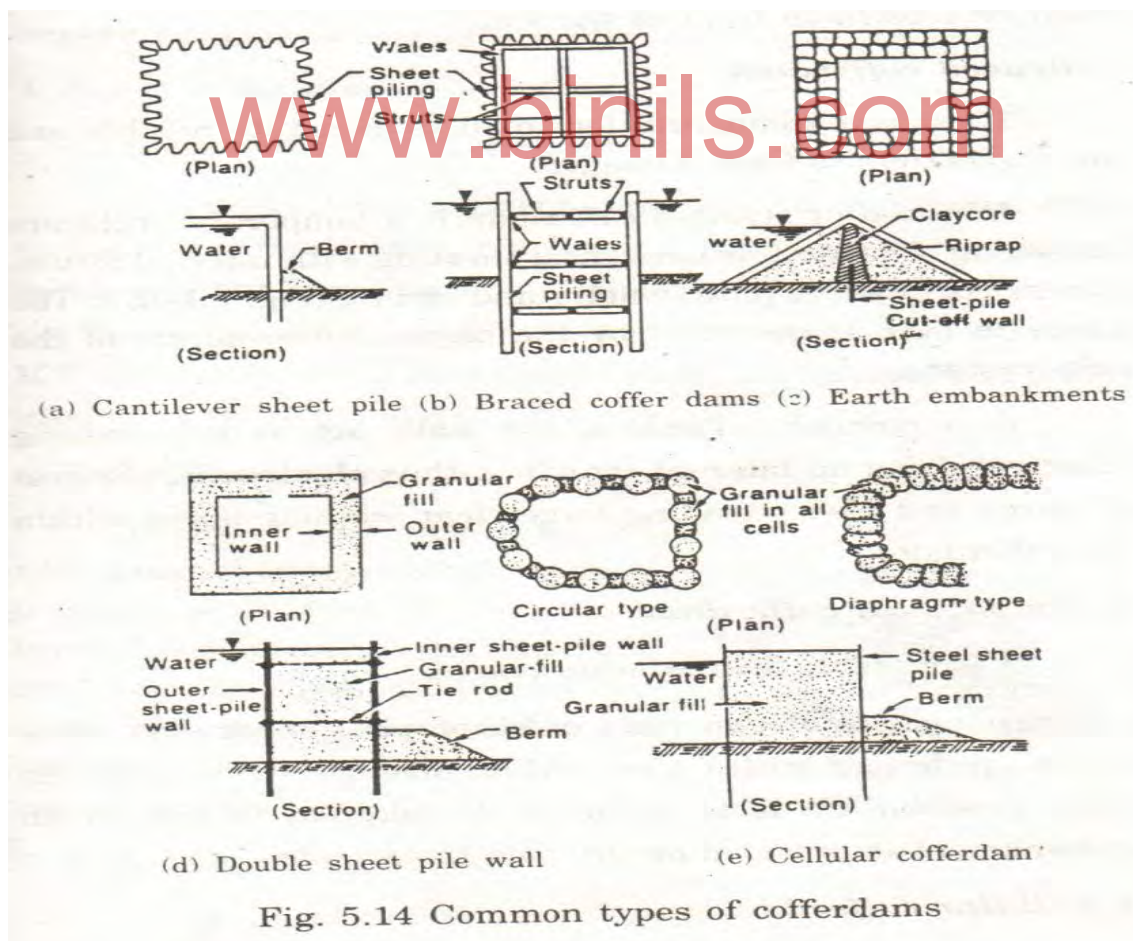

### **1.Cantilever sheet piles**

A sheet piling walls consist of series of piles driven side by side into the ground thus forming a continuous vertical cantilever wall for retaining earth bank. It is suitable for small works and moderate height. It has easily affected by lateral deflection and erosion.

### **2.Braced coffer dam**

It consisting vertical or horizontal sheeting with internal struts. These are economical for moderate heights.

There using circular coffer dam, thus avoid the cost of struts and also give large workspace area.

### **3.Double wall coffer dam**

It consists two rows of sheet piles, which are braced with tie rods. In between the piles, the granular fill is to be made. It is also suitable for moderate height.

### **4. Cellular cofferdam**

The major component of it's the steel cells and cell fill. Sometimes earth beams are also provided on dry side of coffer dam to increase stability. It also classified as circular type, diaphragm and cloverleaf type. These are suitable for moderate and large heights.

### **5.Earth embankment**

It consists of embankment made of earth or other materials enclosing foundation area. The top width and free board will be about 1000mm. The side slope should not be steeper than the natural angle of repose of the material. It is made up of sand, clay and gravel mixture. It has no height limitations.

### **6.Rock fill coffer dam**

It consists of embankment made of 300-600mm thick boulders and earth is placed on water side for imperviousness. Coir mats is used to avoid erosion of earth by water currents.

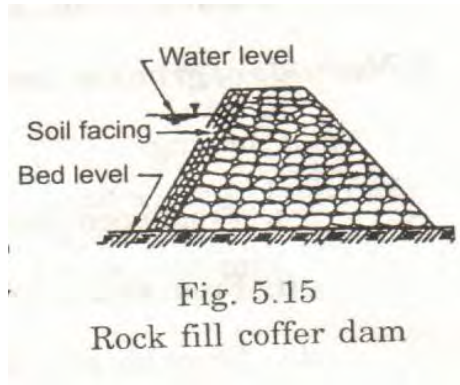

### 7. Bagged earth coffer dam

Where water current is swift there the earth dam cannot be constructed. Bags of loosely filled earth may be dropped in position to form an embankment. This form of dam is called bagged earth cofferdam.

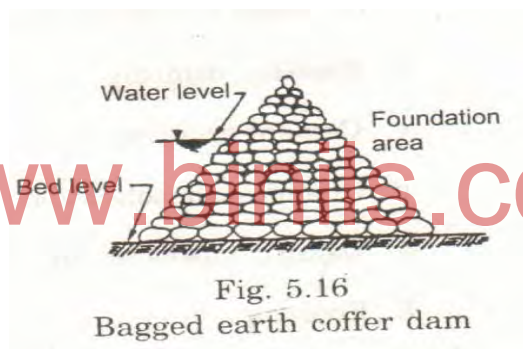

## 5.3 CLASSIFICATION OF BRIDGES

### 5.3.1 CLASSIFICATION OF BRIDGES

#### I. According to IRC loadings

1. Aqueduct (canal over water way)
2. Viaduct (roadway over valley)
3. Pedestrian bridge
4. Road bridge
5. Railway bridges
6. Road cum-ail or pipe line bridge.

## **II. According to material of construction**

1. Timber
2. Masonry
3. Iron
4. Steel
5. Prestressed concrete
6. Reinforced concrete
7. Composite or aluminium bridge

## **III. According to position of bridge floor**

1. Deck bridge
2. Through bridge
3. Semi through bridge

## **IV. According to type of super structure**

1. Slab bridge
2. Beam bridge
3. Truss bridge
4. Arch bridge
5. Suspension bridge

### **5.3.2 CULVERTS**

It is defined as a drain sewer or water course totally enclosed and usually carried under road or railway. It may have one or more spans. It has small linear water way width.

#### **5.3.2.1 CLASSIFICATION OF CULVERTS**

##### **I. According to function**

1. Highway culverts
2. Railway culverts

Designing and loading behavior would be different for these classes.

## II. According to construction

- a) Pipe culverts
- b) Box culverts
- c) Arch culverts
- d) R.C. or stone slab culverts
- e) Steel girder culvert for railways.

### Pipe culverts

Where the depth of flow and discharge is small there pipe culverts are to be used. The discharge is more circular pipes are preferable. Culvert is to be extended to join the pipes and increasing the discharge. Clearance between HFL and crown on the pipe is should be maintained 150mm minimum.

Bottom level of the pipe must laid below the ground level at  $\frac{1}{3}$  rd of diameter of pipe. The diameter of seldom exceeds 1800 mm reinforced and cast iron pipes are used. In case of 600mm stoneware and plain concrete pipes are used. Masonry pitching must be constructed on the both upstream and downstream sides to protect the banks against scouring.

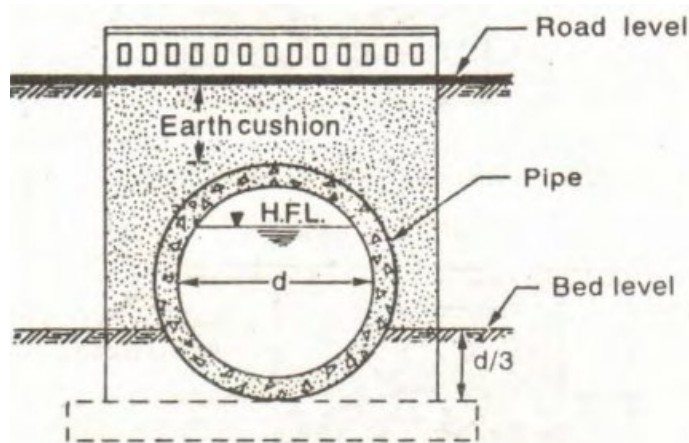

Fig. 5.2 A pipe culvert

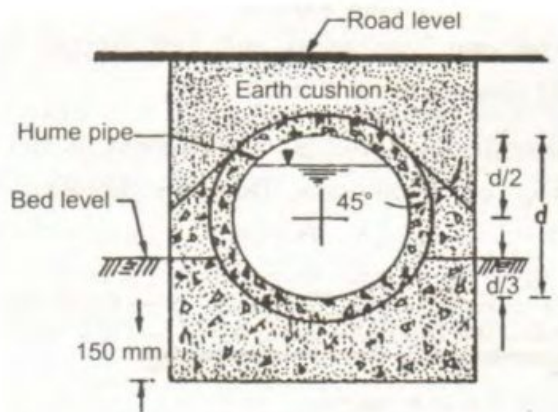

Fig. 5.3 Pipe culvert with Hume pipe

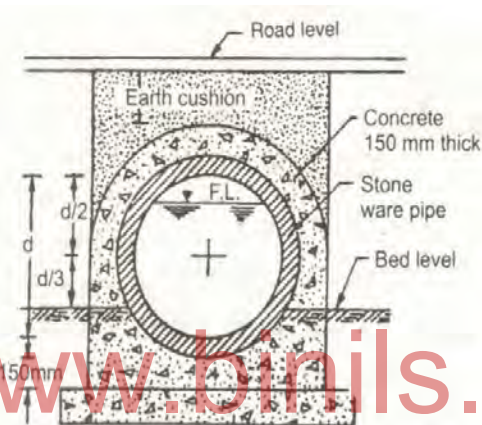

Fig. 5.4 Pipe culvert with stoneware pipe

Pipes usually laid over 150mm thick layer of concrete and covered by earth cushion either 600mm thick for metal roads, or 1200 mm thick earthen roads. If cast iron pipes are provided earth cushion is not required for sufficient depth. The RC pipes are laid by surrounding with cement concrete at an angle of  $45^{\circ}$ .

The minimum interspaced between jointed pipes as 150mm. This space is concreted in relevant manner.

### Box culverts

This type of culvert consist one or more square or rectangular openings made up of masonry or RCC.Box culverts are very common. Stone slabs also used for small culverts. In soft soils, where there is a possibility of scouring and bearing capacity of soil is poor, these culverts are used.

RC box culverts are generally built upto 4m span. All the four sides of culverts are generally built with same cross section and the same reinforcement is provided for the top slab. Depending upon site condition earth cushion may be provided to reduce impact. Bottom slab is to be extended 100mm on either side.

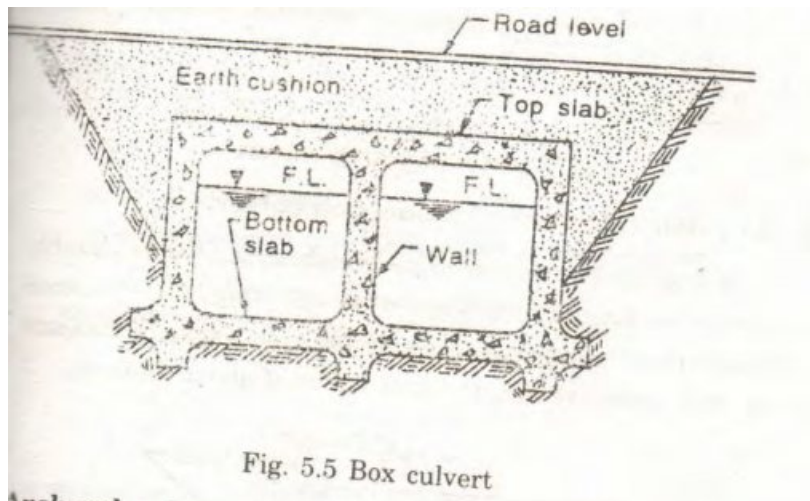

### Arch culvert

For shorter spans (2 to 3m) this type culvert is economical. It may constructed either stone masonry or brick masonry. The thickness of arch is varied 200mm to 300mm depending upon span and loading condition. Minimum earth cushion 450mm should be provided at the crown of arch. To avoid scouring, pitching and curtain wall are provided.

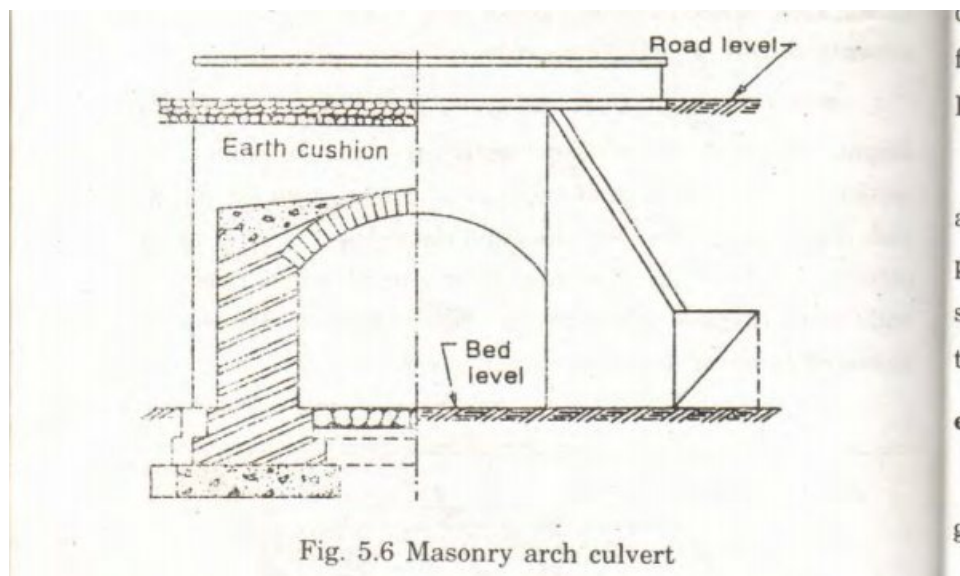



### RC or stone slab culvert

It consists stone slab or RC slab, supported on masonry walls on either side of slabs. We provide up to 2.5m for stone slabs and 6m for RC slabs. RC slabs can be easily done by arranging the reinforcement and concreting. RC culverts are used in railway or highway bridges. Depending upon the site condition wing wall, abutment, parapet (minimum 750mm) and hand rails are provided.

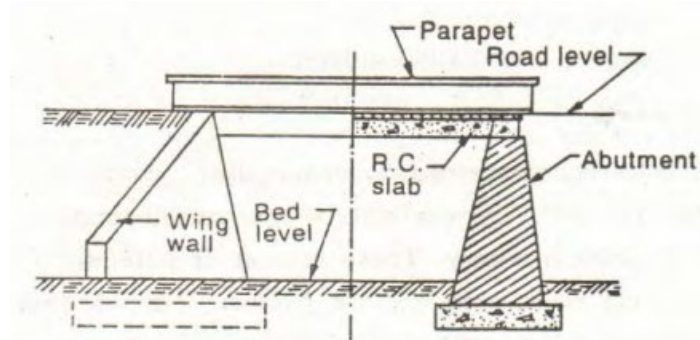

Fig.5.7 Slab culvert

### Steel girder culvert

These types of culverts are provided in railways. Two main girders are placed below the rails. Wooden sleepers are provided over between the girders and the rails are fixed on the sleeper. Sometimes this type of culverts is also known as open deck culverts.

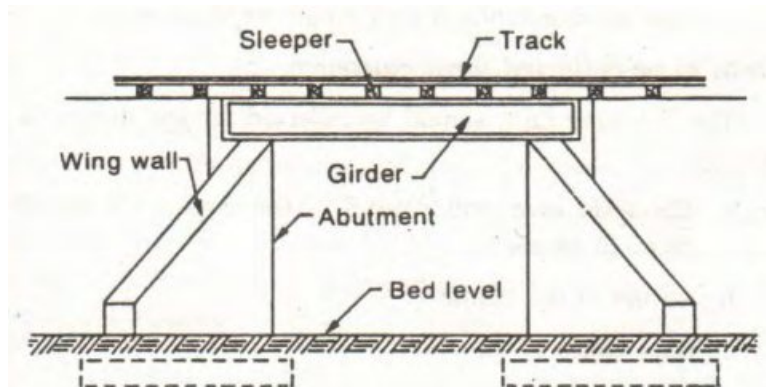

Fig.5.8 Steel girder culvert

### 5.3.3 CAUSEWAYS

These are the structure constructed for crossing highly fluctuating streams which will be under submerged condition during high floods.

#### 5.3.3.1 CONDITIONS TO CONSTRUCT CAUSEWAY

- a. The average flood discharge should not be more than 40% of the highest flood discharge.
- b. The highest flood discharge should not flow in the stream for more than 8 to 10 days in the year and also not more than 4 to 5 hours for these days.

#### 5.3.3.2 CLASSIFICATION

- a. Flush causeway
- b. Low level causeway
- c. High level causeway

#### Flush causeway

These are provided in hilly roads, when the maximum depth of water should not be more than 1700mm in floods and does not exceed 15 days per year.

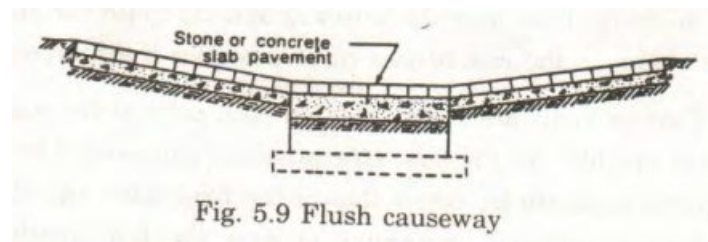

In this type only pavement is done for continuous water flow throughout the year. Vents are not provided. For smooth surface RC slab is to be provided. To avoid scouring, curtain wall is to be constructed on downstream.

#### Low level causeway

It is small submergible bridge without openings with partially vented by a few pipes. In this type small openings of about 300mm to 350mm are provided below the road way slab to allow normal flow without disturbing traffic. Bell mouth entrance provided for the vents should have sufficient waterway. But in monsoon heavy flow over the causeway and the

traffic can stay halted on both sides. Curtain walls are constructed on both up[stream and downstream side of the road. Apron is provided on the downstream side only.

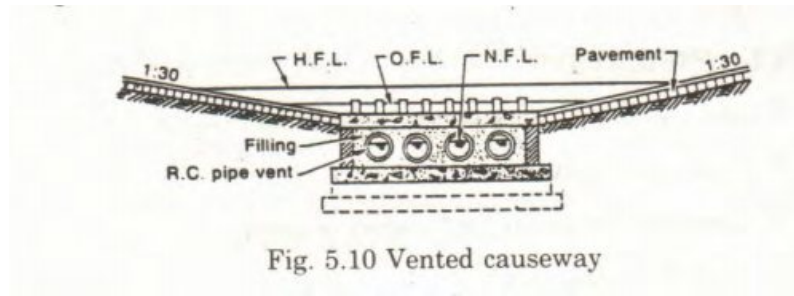

Fig. 5.10 Vented causeway

Under the following circumstances Low level causeway or flush cause way is used.

1. Formation level of road near to the bed level of stream.
2. Flood discharge is for short period.
3. When stone or concrete slab are provided.
4. Breath of river is more.

### High level causeway

[www.binils.com](http://www.binils.com)

It may be defined as a bridge allows normal flood to pass through its vents and heavy flood pass over it. This is also called submergible bridge.

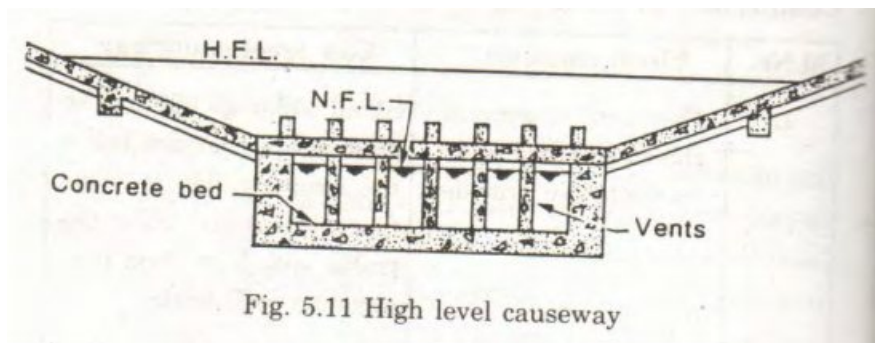

Fig. 5.11 High level causeway

The required vent sections are provided over a concrete bed. Above the vent openings RC slab is laid for traffic movement. Either hand railing or small parapet wall constructed over a road slab on either side.

Stone pitching or apron is laid on downstream side of the bridge. Vent allows 40% of the maximum discharge on it. It is provided under the following circumstances,

1. Good soil available at lower depth.
2. Traffic is small.
3. Duration of heavy flood does not exceed three days at a time and more than six times in a Year.
4. The river width is small and normal flow is continuous and considerable.
5. Difference between normal flood level and highest flood level is more, construction of regular bridge is uneconomical.

## **5.4 SUBSTRUCTURE**

This part will be constructed below the ground level or girder bearing is called Substructure. Following substructures are used for bridge construction.

1. Abutments
2. Piers
3. Wing walls

### **5.4.1 ABUTMENT**

End support of a bridge superstructure is known as abutment.

The face of abutment towards water side kept vertical and the back face towards earth filling may be stepped or battered of 1 in 6. Weep holes are provided for entering sub soil water from back face of abutment. The top of abutment is kept flat or slope to receive superstructure.

#### **5.4.1.1 TYPES OF ABUTMENTS**

1. Abutment for masonry arch bridge
2. Abutment for R.C. arch bridge
3. Abutment for Girder Bridge.

#### **Abutment for masonry arch bridge**

It is designed for the thrust exerted by the arch. The face of water side is usually vertical but may be battered or stepped if required. Earth face may be battered or steeped as required. At the top of arch, sometimes, spandrel filling is included in the abutment.

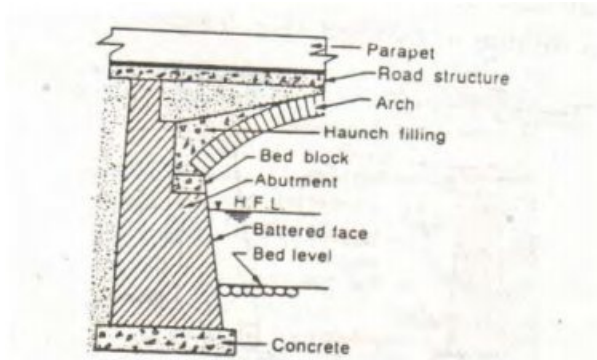

Fig. 5.24 Abutment for masonry arch bridge

**Abutment for R.C. arch bridge**

This abutment is specially designed for the thrust and hinges of R.C arch are provided. It may be constructed with RC as counter fort type of retaining wall, which may be inclined to counter the action of the thrust arch.

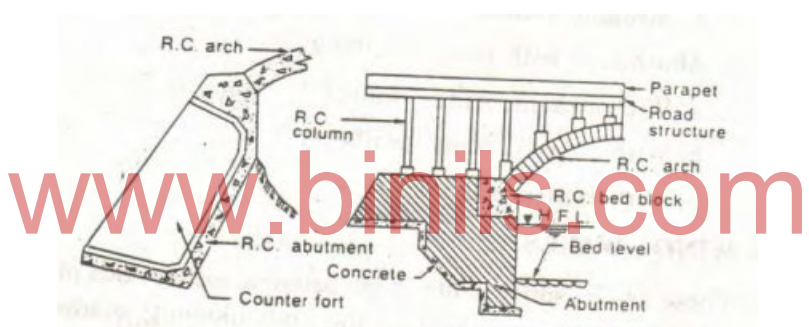

Fig. 5.25 Abutment for R.C. arch bridge

**Abutment for Girder Bridge.**

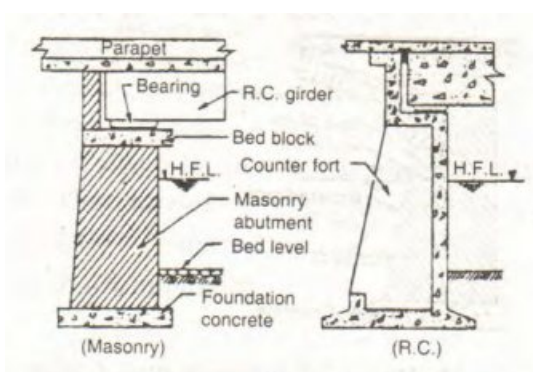

Fig. 5.26 Abutment for girder bridges

It is designed to take the vertical loads of the super structure. It is constructed with masonry or R.C. abutment for Girder Bridge is usually subjected to tilting forward due to

eccentric load acting on it and also due to the deflection caused in the girder. Hence when it is loaded, there is a tendency on it to move away from the soil, bearing against them at the rear. Provisions are made to set the girder on the top of abutment. The faces may be vertical or battered.

## 5.4.2 PIERS

The intermediate supports of a bridge superstructure are called Piers. To divide the total length of bridge into suitable span piers may be constructed. They may be PCC or RCC and may be solid or open type.

### 5.4.2.1 TYPES OF PIERS

1. Abutment pier
2. Dump-bell pier
3. Solid pier
4. Column pier
5. Trestle pier
6. Cylindrical pier
7. Pile pier

#### Abutment pier

In arch bridge, piers are, not designed for lateral thrusts of arches, because the thrust on either side of the pier is equal and opposite. But in very long arch bridges, every third and fourth pier is made of larger section to sustain the effects of heavy unbalanced thrust due to failure of any intermediate pier or arch. Such a pier is known as Abutment pier. It has following uses,

1. Centering can be done partially up to abutment pier
2. Any partial damage caused due to floods and earthquake, it will not extend further beyond the abutment pier.
3. Any repairs can be taken up in stages for the portion comprising the abutment piers.

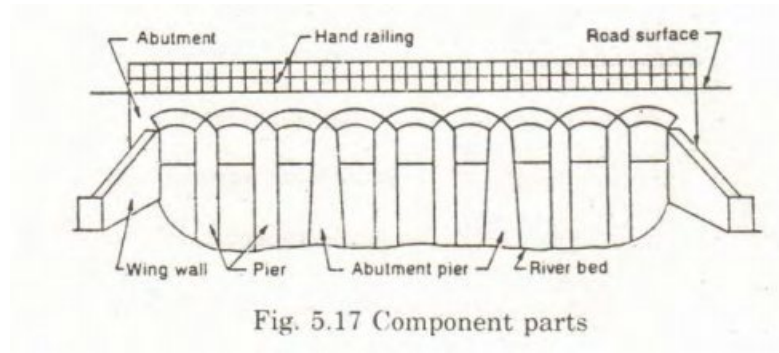

Fig. 5.17 Component parts

### Dumb-bell pier

It is special type of R.C or masonry pier. It consists of column connected by this reinforced concrete web, along their heights, in a direction transverse to the bridge. Such type of piers is known as dumb bell piers. The columns may have a variety of shapes. Bracing are to provide up to HFL top offer resistance to the impact of floating bodies. Above the level twin piers are constructed. If there is no danger of impact of floating bodies and bearing capacity of soil is good, separate foundation may be provided. It has following advantages,

1. It gives maximum moment of inertia.
2. Design is simple and it leads to light reinforcement.
3. Compared to solid pier it is light weight.
4. It is suitable when well foundation is provided.

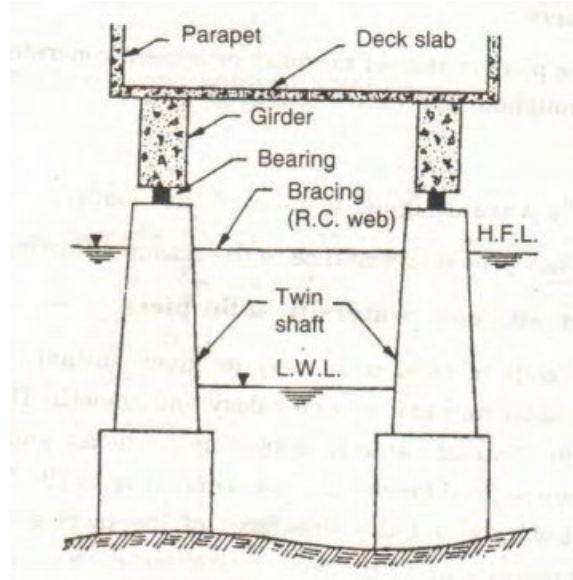

Fig. 5.18 Dumb-bell pier

## Solid piers

Consist of masonry or cement concrete of solid section throughout the entire length of pier called as solid pier. They are designed to take vertical loads. They provide resistance to the action of the floating bodies.

### *Cut-water & ease-water in solid piers*

The ends of solid piers may be given a suitable shape to make entry and exit smooth. The end of the pier upstream side is known as **Cut-water** and that on downstream side is known as **ease-water**. The edges of cut water and the side faces of the piers are usually given taper of 1 in 50 to 1 in 40, for appearance. The cut-water and ease-water are usually triangular or semicircular or they may consists of two parabolic arcs. To avoid the damage during high flood noses of cut waters may be protected by fixing steel angles.\

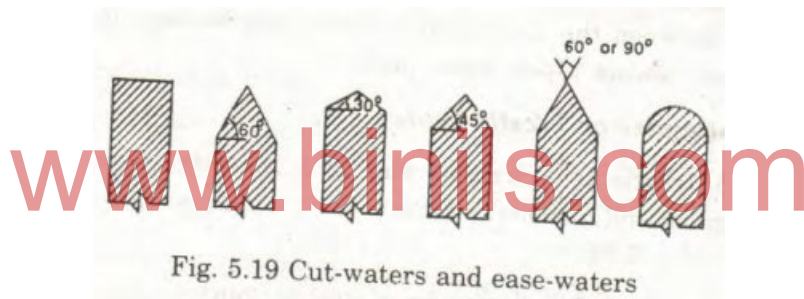
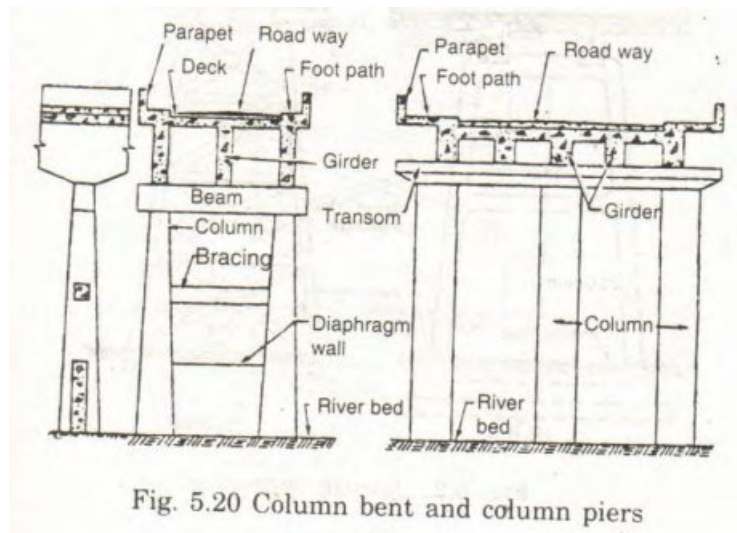

Fig. 5.19 Cut-waters and ease-waters

## Column bent and column pier

A column bent pier is adopted, if the longitudinal beams of girders of the super structure of bridge are closely spaced. The term bent is used to indicate a supporting frame consisting of vertical members and braces. Transverse beams are provided to support transverse beams. The space formed between the longitudinal beams may be used to carry gas pipes, sewage pipes, water pipes.





### Trestle pier or trestle bents

It is framed pier and consists of vertical, rectangular and diagonal members. The trestle bents may be of steel or concrete, the former being quite common. The trestle bents are constructed along viaducts in which there is no fear of impact of floating bodies.

The trestle bents are provided with considerable height and narrow roadway. The wide base at bottom resists wind pressure in a better way. The inclination of frame limited about 1 in 4 to 1 in 8.

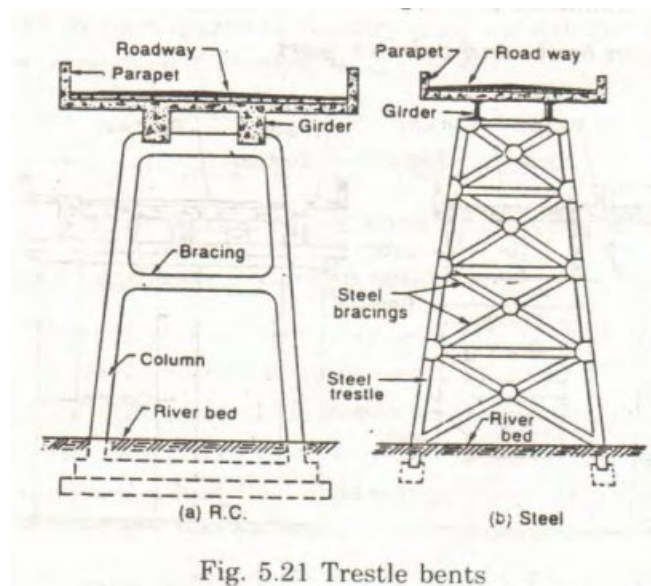

## Cylindrical pier

It consists of mild steel cylinder connected by horizontal and diagonal bracings. These are adopted when foundations are of steel cylinder caissons type. Concrete is poured in steel cylinder and they support the girder of the bridge through suitable bearings.

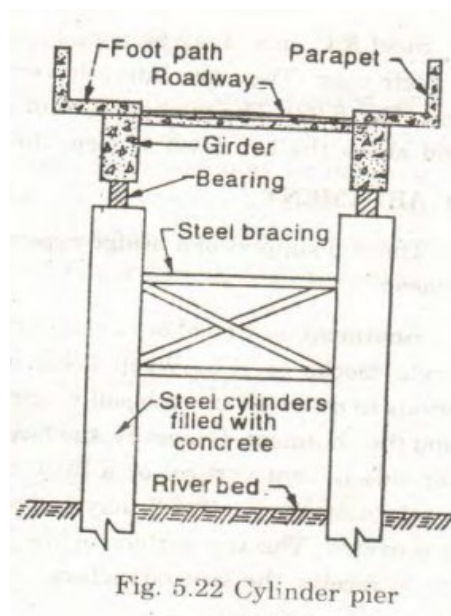

## Pile piers or pile bents

Steel R.C. piles may be used to support the main girders over their caps. They are laterally connected by R.C. or steel frames. The piles may be of screw or disc type. They extend above the bed level to form the foundation.

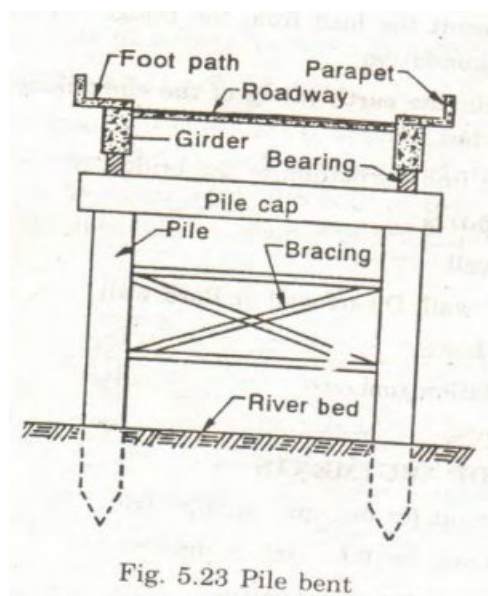

### 5.4.3 WING-WALLS

These are masonry walls constructed on either ends of an abutment to support and protect the embankment, roadway, approach and to guide the water are known as wing-walls.

#### 5.4.3.1 TYPES OF WING WALLS

1. Straight wing walls
2. Splayed wing walls
3. Return wing walls

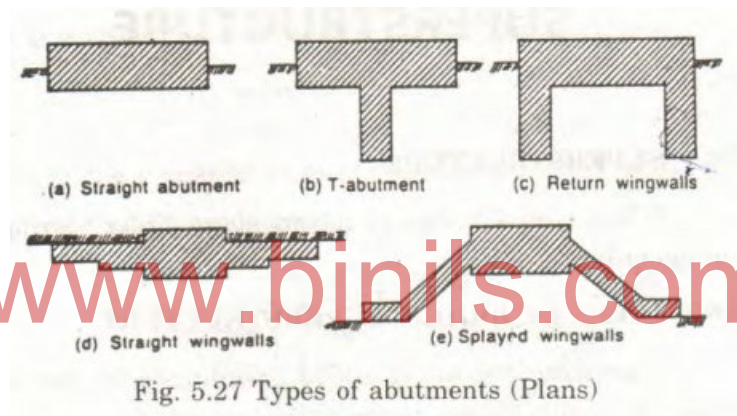

## 5.5 SUPERSTRUCTURE

The part will be constructed above the ground level or girder bearing is called super structure.

### 5.5.1 TYPES OF BRIDGES ACCORDING TO STRUCTURAL SYSTEM

1. beam bridges,
2. cantilever bridges,
3. arch bridges,
4. truss bridges,
5. suspension bridges,
6. cable-stayed bridges

### **Beam Bridge**

It is similar to the long bridge. It is now made from steel 'T' beams, box girders, reinforced concrete, or post-tensioned concrete. It is frequently used in pedestrian bridges and for highway overpasses. It is in structural terms the simplest of the many bridge types. It consists of one or more horizontal beams with 2 supports usually on either end.

### **Cantilever bridge**

It is a bridge built using cantilevers: structures that project horizontally into space, supported on only one end. A simple cantilever span is formed by two cantilever arms extending from opposite sides of the obstacle to be crossed, meeting at the center

### **Arch bridge**

An arch bridge is a semicircular structure with abutments on each end. The design of the arch, the semicircle, naturally diverts the weight from the bridge deck to the abutments.

### **Truss bridge**

A truss bridge is a bridge composed of connected elements (typically straight) which may be subjected to tension, compression, or sometimes both in response to dynamic loads. Truss bridges are one of the oldest types of modern bridges. Truss type of bridge structure has a fairly simple design and is particularly cheap to construct owing to its efficient use of materials.

### **Suspension Bridges**

Suspension bridge is a type of bridge where the main load-carrying elements are hung from suspension cables. Suspension bridges have two tall towers through which the cables are strung.

### **Cable stayed bridges**

A cable-stayed bridge is a bridge that consists of one or more columns (normally referred to as towers or pylons), with cables supporting the bridge deck

## 5.5.2 SIMPLE BRIDGE

Simple bridge is simplest type of bridge, it is made of two supports which hold up the slab or beam. It is least expensive.

### 5.5.2.1 TYPES OF SIMPLE BRIDGE ACCORDING TO BRIDGE FLOOR

1. Deck type
2. Through type
3. Semi-through type

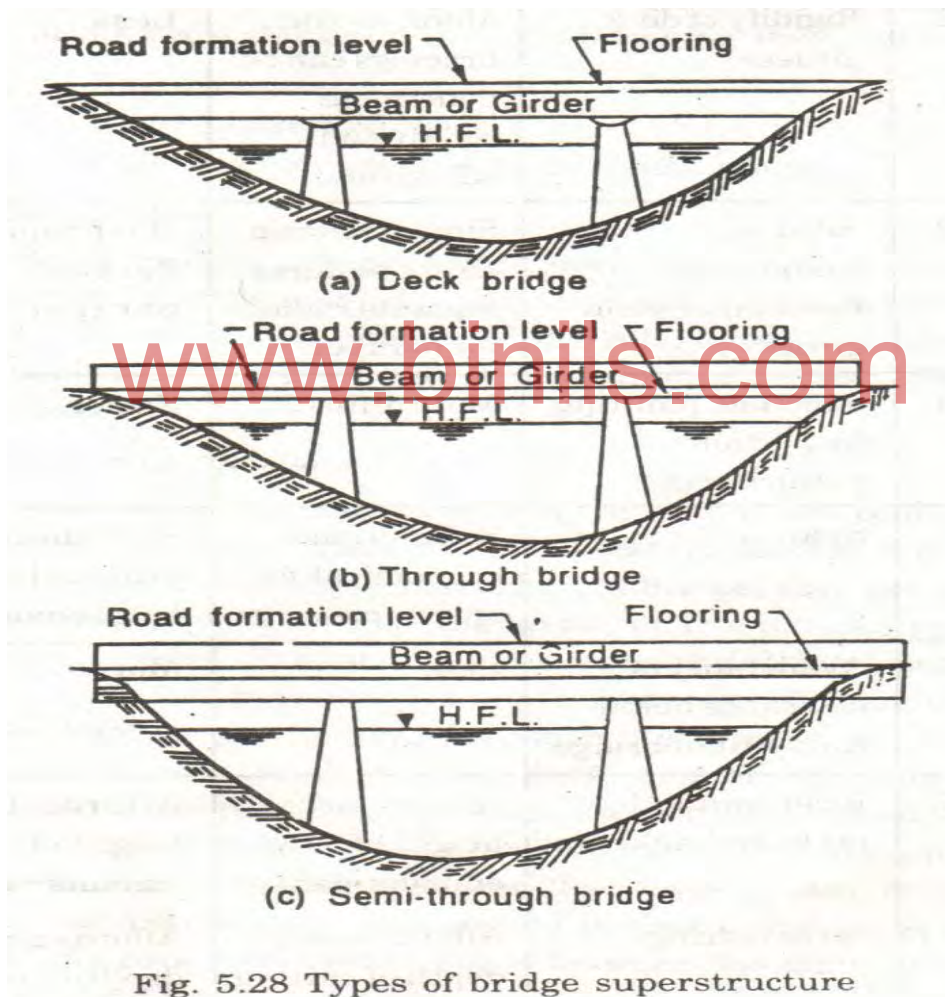

### Deck type

Flooring is supported over the top flange or beam of the girder is called as deck Type Bridge. Super structure is accommodated between HFL and road formation level with suitable clearance.

### Through type

Flooring is supported on the bottom flange or beam by means of cross girder is called as Through Type Bridge. Super structures are made above road formation level on either side of the bridge.

### Semi-through type

Flooring is supported near the mid height of the girder by means of cross girder is called as Semi-through type Bridge. Super structure of bridge is partially accommodated between HFL and road formation level and partially projecting above road formation level.

### 5.5.3 CONTINUOUS BRIDGE

Length of the bridge is more (about 50m) superstructures may be continuous over piers and end abutments. Slab type, T-beam type or box type decks are used in this type of bridge. As this is continuous over the piers, the magnitude of bending moment at support is more than mid span. Hence, moment of inertia of the girder at support is more than the mid span.

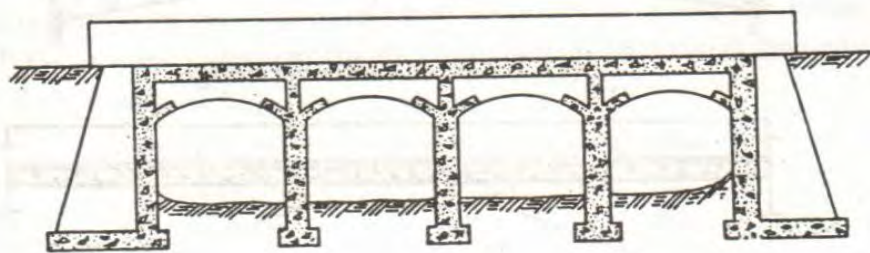

Fig. 5.30 Continuous bridges (R.C.)

### Merits:

1. Quantity of steel and concrete consumption is low

2. Provide more head room due to less depth in mid span.
3. Under heavy loads It has less vibration and deformation.
4. Only one bearing is provided at each of the two supports.
5. Low maintenance.

### Demerits

1. Slight settlement causes adverse effects.
2. Difficult to design.
3. More detailing of reinforcement is required
4. Skilled labor required for construction.

### 5.5.3 CANTILEVER BRIDGE

One end of the cantilever is fixed and the other free ends just meet at the center of spans. It is constructed may be of steel or R.C. This type of construction is achieved by providing good fixity at supports and providing hinges at center of the span or somewhere at the span. In R.C bridge, depth of slab is to be increased towards support.

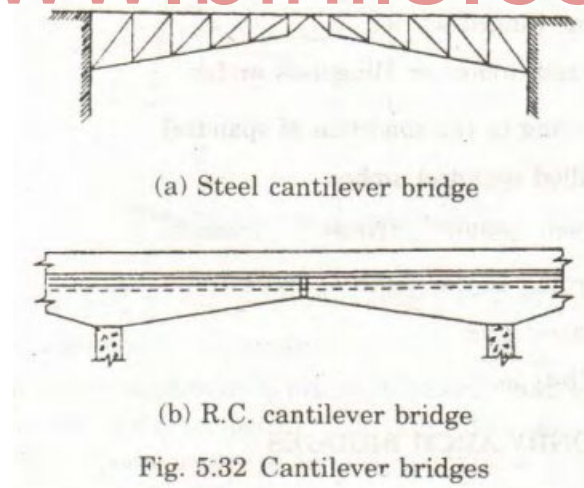

### 5.5.4 BALANCED CANTILEVER BRIDGE

One portion of span rests over or suspended from other portion or portions of span. In the piers end portions are fixed. And hinges are provided at the point of contra flexure of a continuous span. Intermediate span will be suspended or supported between the contra flexure point is called articulation. It is made of steel or R.C.

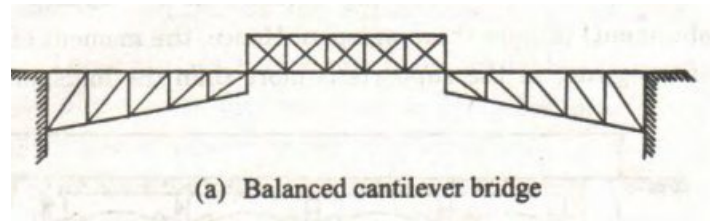

Weight and cross section of cantilevers are determined after trying several possible combinations. The length of cantilever span is  $1/5$  to  $1/3$  of the main supported span.

This type construction is demand extreme care and skill in design.

#### **Merits:**

1. Require less quantity of steel and concrete.
2. Due to less reaction piers are lighter and economical.
3. Maintenance cost is low.
4. One bearing is required at every pier due to continuity of girder at the piers.

### **5.5.5 ARCH BRIDGE**

Roadways are constructed over the arch, rests on pier and on abutment is called arch bridge. It may be constructed R.C. or steel or masonry or prestressed concrete.

#### **5.5.5.1 CLASSIFICATION OF ARCH BRIDGES**

##### **1. Based on material used for construction**

- i. Masonry arches
- ii. R.C. arches
- iii. Steel arches

##### **2. Based the conditions of spandrel**

- i. Filled spandrel arches
- ii. Closed spandrel arches

##### **3. Based on their shape**

- i. Semi-circular arches
- ii. Semi-elliptical arches
- iii. Segmental arches
- iv. Parabolic arches

##### **4. Based on number of hinges**



- i. Three hinged arches
- ii. Two hinged arches
- iii. One hinged arches
- iv. Fixed arches or hinge less arches

**5. Based the width of arches.**

- i. Barrel type
- ii. Rib type

**Masonry arch bridges**

It is constructed may be of brick or stone. These are suitable for small spans and where more head way is required. It is simple to construct, have a long life and cheap in construction cost.

**Spandrel arch bridges**

**1.Filled spandrel arch bridges**

It may have curved slab or solid barrel arch spanning across the arched ribs of narrow widths spanning between two skewbacks.

**2.Open arch spandrel**

Ratio of rise to span is more in this type of bridge and is economical. If the arch ring is barrel type, walls are constructed with suitable dimensions on the extrados of the barrel. Such walls are called curtain wall. If arch is rib type, columns are constructed on them spandrel portion with suitable spacing and kept same. One line of column are transversely connected by arch beams at their top. The flooring rests on the curtain walls or columns.

**Merits:**

1. Dead load will be reduced for no filling.
2. Bending moment and tensile stress are reduced.
3. Less cost.

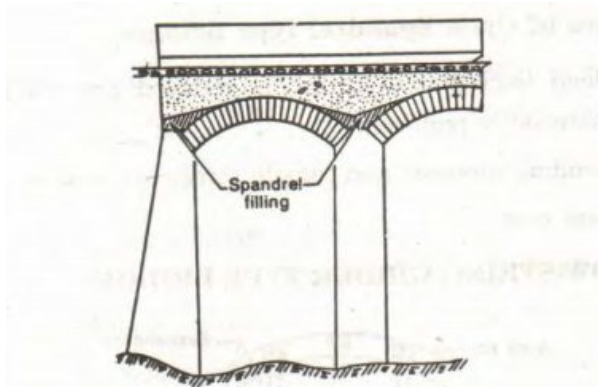

Fig. 5.33 Filled spandrel masonry arch bridge

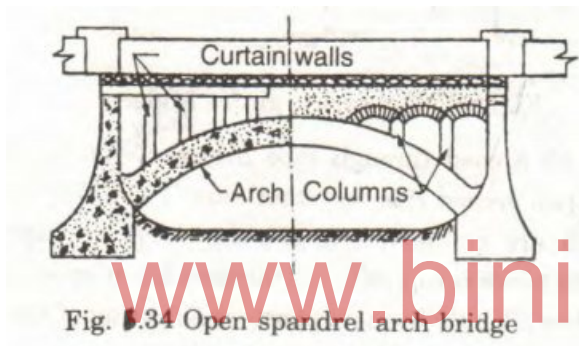

Fig. 5.34 Open spandrel arch bridge

### 5.5.6 BOW-STRING GIRDER TYPE BRIDGE

It is an arched through type bridge. Arch rib is located either side of bridge. Ends of the arch are connected to the tie beam at springing level. Tie beam connected to arch rib by suspenders. Flooring rests on tie beam and load as transferred by suspenders.

To eliminate the horizontal thrust on abutment, rollers are provided. Abutments are made to resist vertical reaction. For design purpose arch is considered as curved beam. Two arches of the bridges are connected together by cross beams at the top to give better lateral rigidity. This type of bridges can be built up to 175m.

Merits:

1. Economical
2. Good appearance.
3. Provide where more head room required
4. Support section is light.

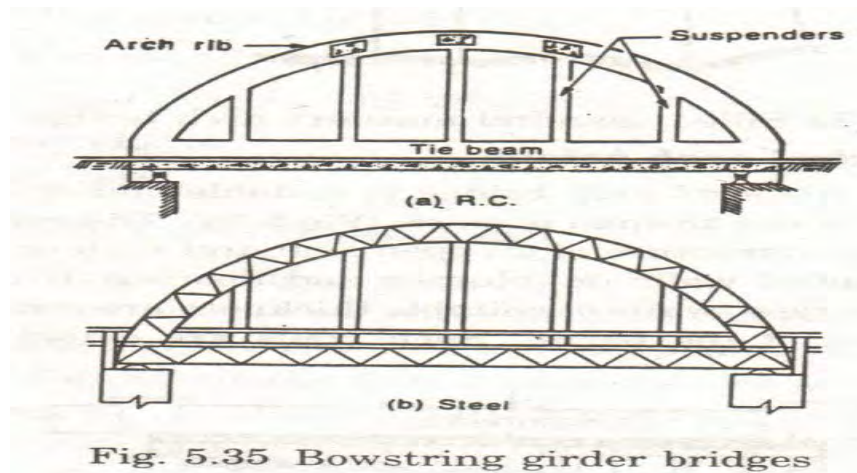

### 5.5.7 RIGID FRAME BRIDGE.

The super structure and sub structure are constructed monolithically the frames are called rigid frames. It is made by either R.C. or steel.

The width of the frame is the same as the width of the bridge. The legs of the portal may be hinged or fixed to the foundation. In multiple span, expansion gap is kept between two portal and at the top, and is sealed by a copper U-strip filled with bituminous material.

[www.binils.com](http://www.binils.com)

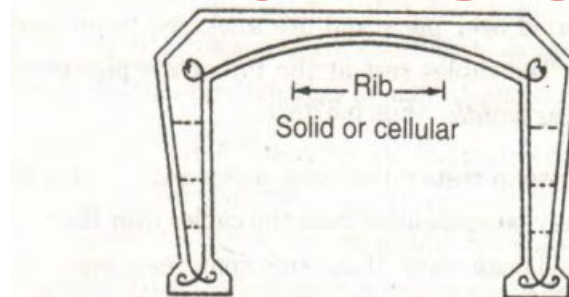
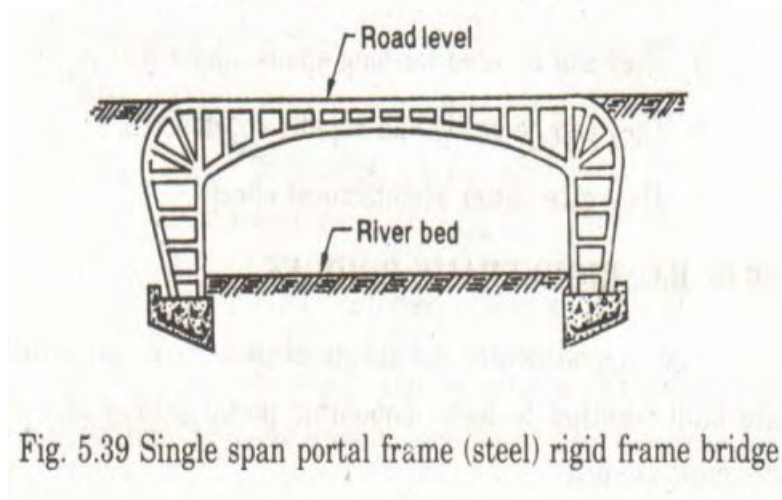

Fig. 5.38 Single portal single span (R.C.) bridge



### Merits:

1. Bearings are not required.
2. More stable.
3. The bridge is least obstructed since slender section are used for supporting piers.

### 5.5.8 SUSPENSION BRIDGE

These types of bridges utilize wire rope which support the road way by suspenders. The wire ropes or cables are carried over piers and are anchored to jumpers left in good rocks. The cables rest at the top of pier in special casing called as saddle.

Side span rest either over a substructure or suspended cables over them. These cables are called as backstays. The back stays are straight, if the span is supported by sub structure. If supported by suspenders It is curved in shape.



Under heavy loads position of suspension cables are changed. To overcome this, they are stiffened with roadways are bracing with chains. On loading, sagging of bridge is taken as  $1/10$  to  $1/6$  of the span. To counteract the sag camber will be provided.

Merits:

1. It can be easily and rapidly constructed.
2. It gives better architectural appearance.
3. To avoid the pier along the river bed.
4. It cheap compared to other types.
5. Light in weight.
6. It can be used for long spans up to 600m.

### 5.5.9 CONTINUOUS STEEL BRIDGES

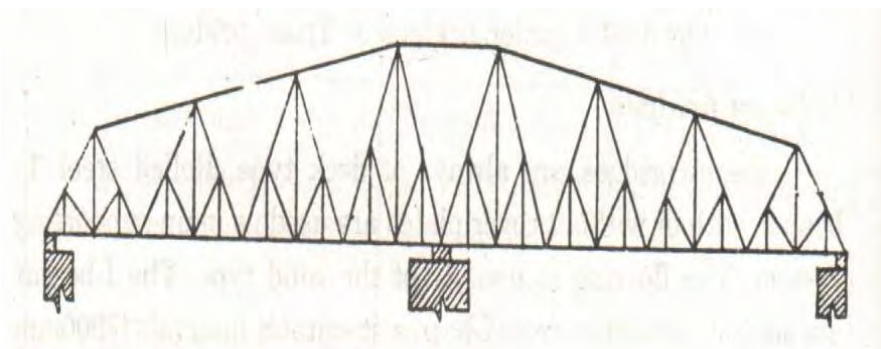

Fig. 5.29 Continuous bridge (Steel)

[www.binils.com](http://www.binils.com)

In this bridge, the trusses are supported at intermediate points. the bearing at one intermediate support are of rocker type but other supports must have bearings that allow horizontal movement. The flooring and bracing may be open or solid type.

Bending moment considerably small compared to simply supported beam. The values of bending moment and shearing force considerably alter on slight sinking of any support. If it is heavy structure; it cannot be lifted up as one piece ordinarily.

### 5.5.10 STEEL ARCHED BRIDGE

Plate girders or trusses are used in the form of arches. They may be fixed, or hinged, two hinged or three hinged and may be deck type, through type or semi- through type. The over all depth may be constant or varying. They are usually circular or parabolic shape in elevation and may have solid open web. These are suitable for long single span construction with steel. If necessary, bearings are provided to bridge super structure.

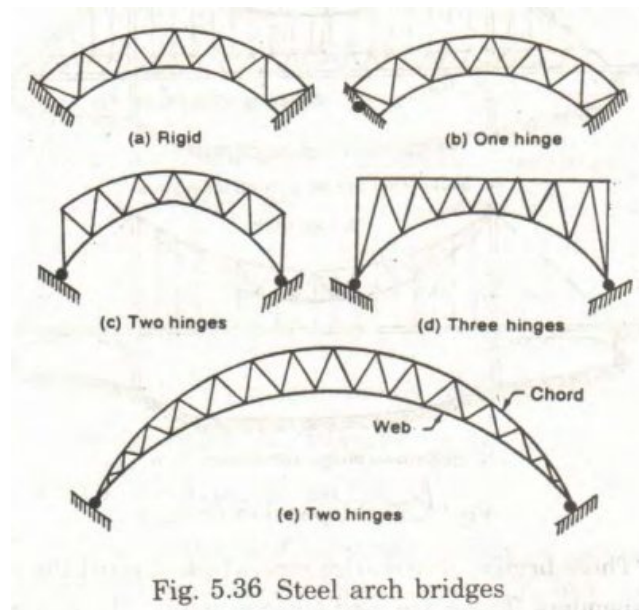

## 5.6 BRIDGE BEARING

It is a device used in long span bridges to avoid development of high stresses in main girders due to temperature changes and deflection.

### 5.6.1 PURPOSE OF BEARING

1. For distribution of the load from superstructure to substructure to reduce intensity of pressure within the safe limits of the materials of construction.
2. It should be capable of accommodating maximum expected deck moment and rotation with least possible resisting force.

### 5.6.2 IMPORTANCE OF BEARINGS

1. When loaded, it allows the girder to move freely along the axis.
2. To take angular movement at the support.
3. To allow free movement to the girder incase variation in its length is caused due to change in temperature

\

### 5.6.3 TYPES OF BEARINGS

1. Fixed bearing
2. Rocker-roller bearing
3. Rocker bearing
4. Rocker bearing with curved bottom
5. Knuckle bearing
6. Sliding plate bearing
7. Sole plate on curved bed plate bearing

#### Fixed bearing

To prevent any longitudinal moment of the girders fixed bearings are provided. They are suitable only for small spans up to 12m. They are classified as,

1. Shallow plate bearing
2. Deep base bearing
3. Laminated rubber fixed bearing
4. Cement mortar pad

#### Rocker-roller bearing

These are suitable for largest spans in these bearing the bottom shoe rest on the cylindrical roller which roll on a number of rails placed over the masonry or cast steel block or steel plate. This bearing allows free longitudinal as well as angular movements of the main girder of the bridge connected to the top shoe.

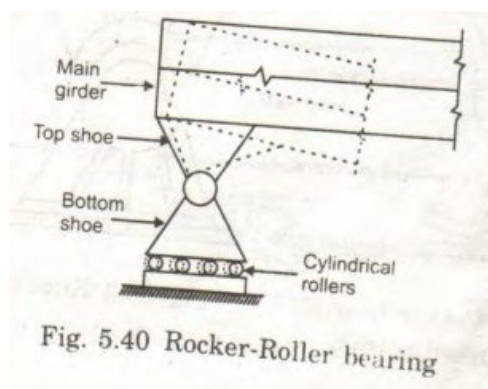

## Rocker bearing

These bearings are also suitable for larger spans, say more than 21 metres. This is similar to the Roller-rocker bearings. It has a 20cm radius circular rocker pin placed between the top and bottom shoes, having the same radius  $\frac{2}{3}$  rd of the circumference of the rockers are covered by the shoes and saddle cover. The top shoe is inverted and the bottom shoe is directly placed on the masonry or on steel block provided on the top of the masonry.

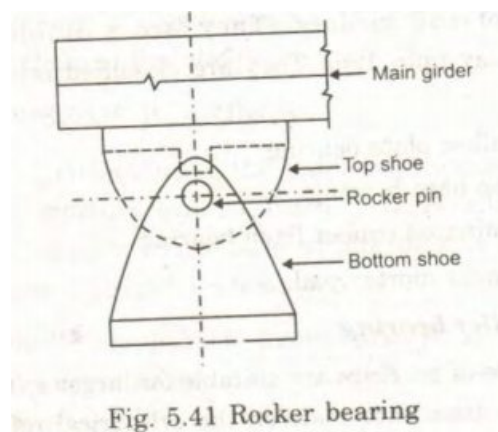

Fig. 5.41 Rocker bearing

## Rocker bearing with curved bottom

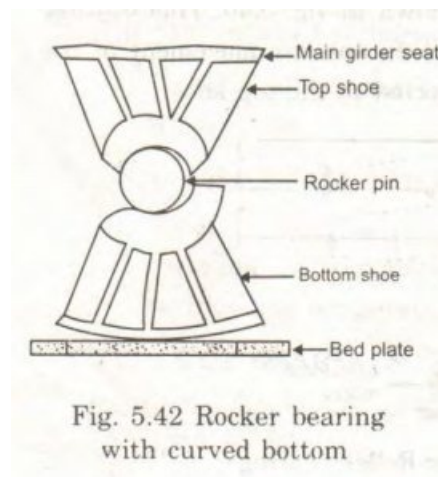

Fig. 5.42 Rocker bearing with curved bottom

This bearing allows free longitudinal as well as angular movement to the bridge girder. In this bearing, the upper portion is similar to the Rocker bearing. The bottom shoe has a curved bottom surface.



## Knuckle bearing

This bearing allows only angular movements of the girder fixed on the top shoe. The top shoe has a semi-circular concave surface and the bottom shoe has a semi-circular concave surface both having the same radius.

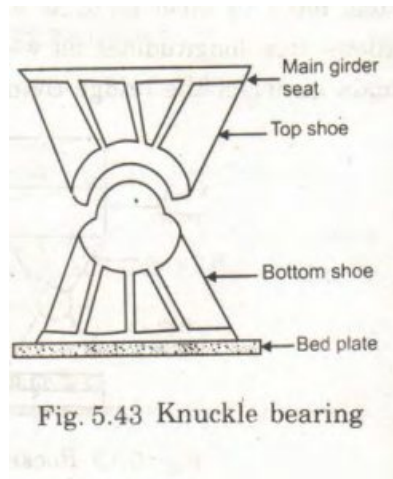

## Sliding plate bearing

It consists of a sole plate fixed to the bottom of the girder of the bridge and rests on a wall plate. The wall plate is rigidly connected to the masonry or bed block by bolts in such a way that the sole plate is made free to slide over the wall plate by providing slotted holes in the sole plate. Thus the sliding plate bearing allows longitudinal expansion or contraction due to the variations in temperature or live loads etc.,

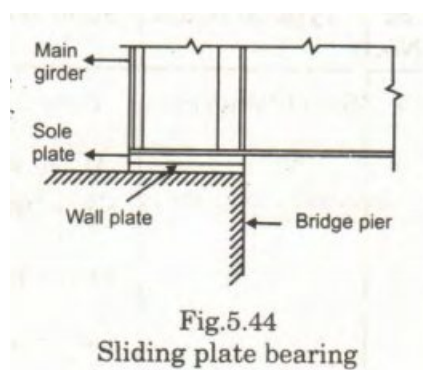

## Sole plate on curved bed plate bearing

This type of bearing is useful where the sole plate is in the girder bridge. The sole plate is fixed on the girder of the bridge and rests on a curved bed plate fixed in the masonry. The

sole plate can move angularly in the bed plate when the main girder of the bridge deflects due to loads.

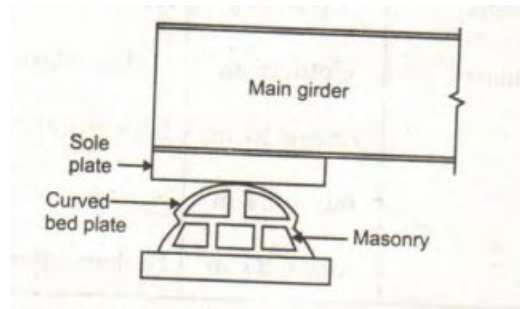

Fig.5.45 Sole plate on curved bed plate

#### 5.6.4 ELASTOMERIC BEARINGS

Steel reinforced neoprene (synthetic rubber) bearings are used in compression. It is known as elastomeric bearings. They composed of multiple laminates of elastomeric material separated by steel reinforcement. Among all different kinds of bearing, elastomeric bearings are the best known and most often used.

